



# ***SymbiLink™ Owners Manual***

# Contents

Balanced Signal Lines .....	3
The SymbiLink™ Balanced Line System .....	4
The SymbiLink™ Line Driver / Transmitter .....	5
The SymbiLink™ Cable .....	6
The SymbiLink™ Receiver .....	7
How a Balanced Signal System Works .....	8
Impedance Difference .....	9
Balanced or Unbalanced? .....	10
SymbiLink™ Cables and Adapters .....	11
Cable Connector End View.....	12
SLB-TP4.....	13
SLB-R / SLB-R4.....	14
SLB-U.....	15
VFM.CBL.....	16
SLB-U Endplates .....	17
SLB-U Setup Table .....	18

**SX-SL Modules .....19**

**SymbiLink™ Specifications .....20**

**PSI-HPSL .....21**

**System Drawings .....22**

**Technical Assistance .....36**

# Balanced Signal Lines

## The Problems:

The very nature of the RCA design makes it less than ideal for automotive use. We have two major problems in cars that are not found in the home. First, the car has an alternator that produces electrical current and sends it to all areas of the car through the car's electrical system. This noise will try to find its way into the signal path through the electrical ground connection of the stereo. In addition to creating noise, the electrical system can also degrade sound by passing various frequencies into the signal wire and distorting the signal.

RCA cables are susceptible to these problems by nature of their design. RCA's provide only three discrete paths for the signal. Right and left positive each have an amplified path from head unit to amplifier, but both negative paths must share the shield ground (See diagrams). This sets an open path from your signal directly to the chassis of the head unit and from there directly to the car's alternator (The very source of the noise).

Another problem is run length. While home components are close together, the components in a car system are spread throughout the vehicle. It's not unusual to have 20 to 60 feet of signal cable in a car installation. RCA cabling is High Impedance by nature. This, combined with being able to amplify only the positive lead, creates considerable signal loss between the head unit and the amplifier.

## The Solution:

One answer to all the problems...Balanced signal lines. A balanced signal transmission system provides separate, discrete signal paths for both positive and negative sides of each channel. This eliminates the reference between the signal negative and the radio chassis. thus closing the path between the cars electrical system and the stereo signal. (See diagrams)

The SymbiLink™ Balanced system takes the balanced signal even further. SymbiLink™ combines balanced signals with our SymbiLink™ Line transformer and our SymbiLink™ cable. In one step we have eliminated all the problems inherent to signal transmission in the automotive environment.

The SymbiLink™ Balanced System provides low impedance, high voltage, and balanced signal for the best sound possible in a car.

# The SymbiLink™ Balanced Line System

The “Symmetrical, Bi-directional Link” was originally developed by General Motor’s scientists, in the early ‘90s, to provide high speed, noise free, data transmission between the ECMs and computers of cars in the digital age. Recently, computer engineers have discovered the system, which they have termed “Fire Wire” and have adopted it as the IEEE-1394, data transmission standard.

ARPA of America adopted the system for use in its **Zapco** brand of amplifiers and signal processors some years ago. In 1993, ARPA engineers realized that this new technology was the ideal system for audio signal transmission. The system, with three sets of shielded, twisted pair wires, allowed them to take Zapco’s differentially balanced input stage to the next level of audio performance. A true “Balanced” audio transmission system for the car environment.

ARPA’s version of the system, named SymbiLink™, consists of two elements. The first is a differentially balanced line driver, to provide a high voltage, low impedance, balanced signal source. Secondly, the SymbiLink™ system uses the SymbiLink™ cable itself. This cable provides a separate positive and negative signal path for each signal channel. It also provides a third pair of shielded wires, which can be used to move  $\pm 15v$ , through the system to power the various components.

These components result in what we at ARPA of America believe is clearly the best system of audio signal transmission ever developed. All of the US built Zapco products now use the SymbiLink™ Balanced Line system. On the following pages we will show you the various SymbiLink™ products and their features, as well as explain the advantages of SymbiLink™ and provide some technical data on the cables themselves.

So, enjoy this manual! We hope you will read it all the way through. We have tried to include all the information you will need to enjoy the full potential of your new SymbiLink™ product.

# The SymbiLink™ Line Driver / Transmitter

The SymbiLink™ system starts with the line driver. Here, the standard, unbalanced 3 wire (RCA) input goes through a differential input stage to eliminate most of the noise picked up between the deck and the line driver, and yield separate positive and negative leads for each channel, with no reference to chassis ground (The diagram below shows one channel). Then we amplify each side of the signal by up to 12dB and send it out as a low impedance signal.

Most importantly, the differential input stage has sent an out of phase component of the noise, common to the two channels, down the negative signal path. When the signal gets to the receiver, and the two signals are combined, the two noise components cancel each other out. Result: No Noise

Because we now have a low impedance, high voltage, signal, we can now run long distances of cable with very little signal loss. This is a major reason that professional sound installations have been using balanced line transmission systems for years.

By amplifying the level of the signal, relative to the inherent noise, you also greatly decrease the volume of the noise floor in any audio system. With a 12 dB signal boost, noise decreases in the system by a factor of over 10 times.

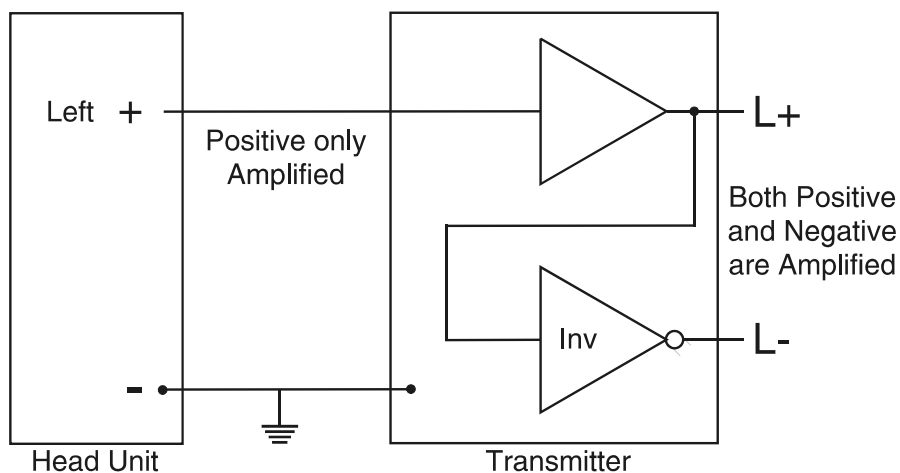

# The SymbiLink™ Cable

Integral to the SymbiLink™ Balanced System is the SymbiLink™ cable itself. ARPA engineers recognized, years ago, the value of the cable system now called "Fire Wire" by computer engineers. This design, also called the IEEE 1394 data transmission standard, provides the ideal wire for a balanced signal transmission.

After we have converted the unbalanced signal to a low impedance, high voltage, balanced signal, we have to get the signal back to the amplifier. The SymbiLink™ cable is perfect. It consists of three "twisted pair" sets of wire, each with its own shield. One provides positive, negative and shield for the right channel, one holds positive, negative, and shield for the left channel, and the last set gives plus and minus 15 volts and shield to power any SymbiLink™ processor when you are using SymbiLink™ equipped amplifiers.

Because you now have a low-impedance, high voltage signal, smaller gauge wire can be used effectively. So, an extra advantage of the SymbiLink™ system is that the cables are considerably smaller.

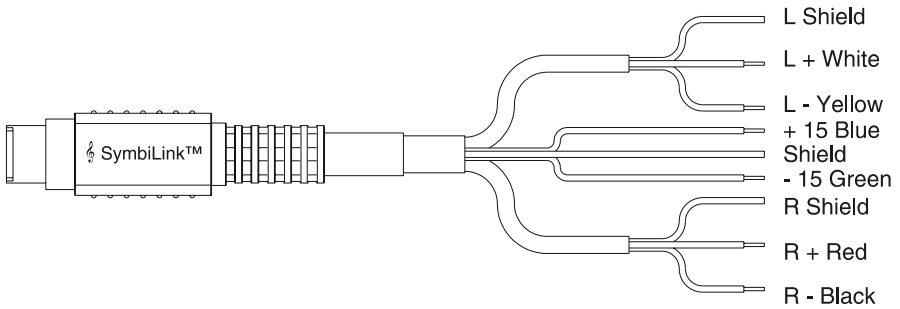

## The SymbiLink™ Receiver

The final stage in the SymbiLink™ System is the balanced line receiver. When the two high voltage signals get to the amplifier, they must be converted back to a single path for each channel. When this is done, any noise common to the channels is eliminated. Another effect of the conversion is that the amplitude of the original sine wave is doubled.

So, now we have a signal that has no induced noise, has no induced distortion, has virtually no signal loss, and has dropped our noise floor by a factor of over 10 times. We use 5 times less space than we would use with RCA type co-axial cable. And, to top it off, we spend far less money than we would for high-end RCA cables. Are we happy? Yes indeed.

The diagram below shows the receiver portion for one channel.

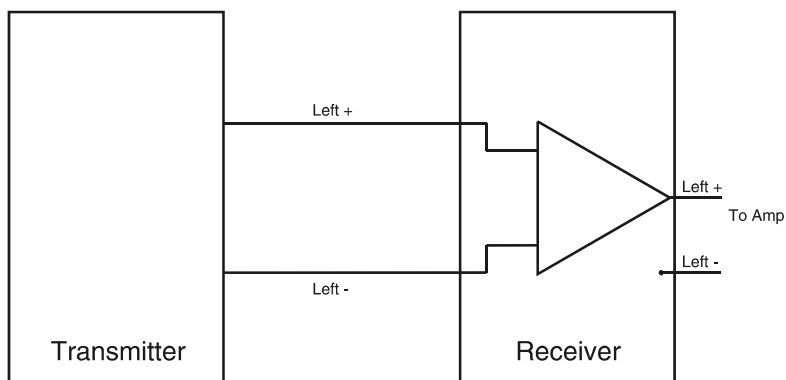

All SymbiLink™ equipped amplifiers have the receivers built in. If you are using the SymbiLink™ System as a “stand alone” signal system with a non-SymbiLink™ amplifier, you can use the SLB-R (stereo) or SLB-R4 (4 channel) to receive the balanced signal and convert it so your standard amp can have the advantages of the SymbiLink™ System.



# How a Balanced Signal System Works

## How Balanced Systems Reject Noise in an Audio System

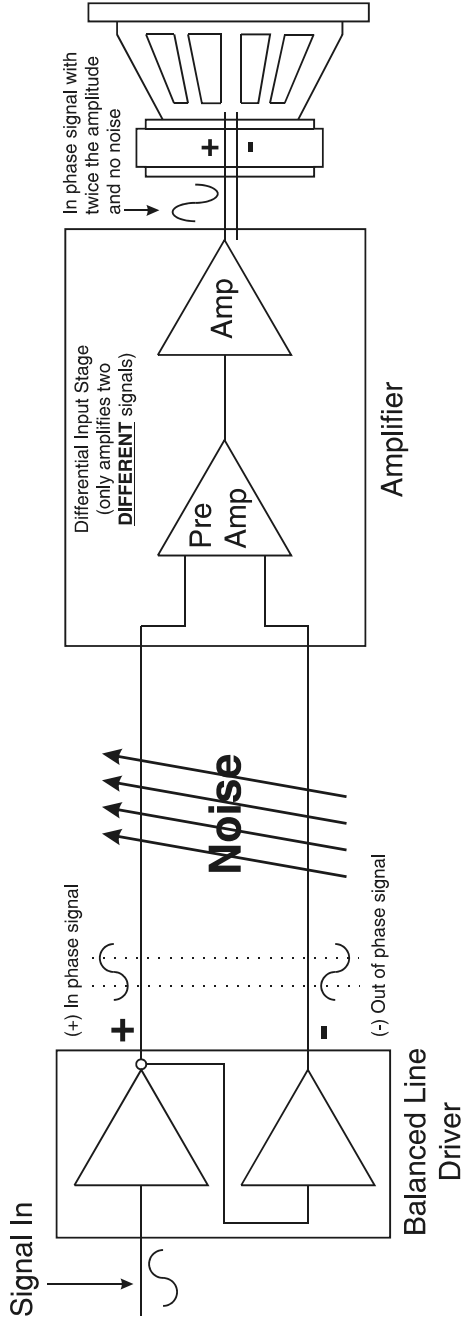

# Impedance Difference

## Low Impedance is Better

### High Impedance

Since the impedance is high, noise travels easily into the amplifier instead of traveling to ground through the resistor.

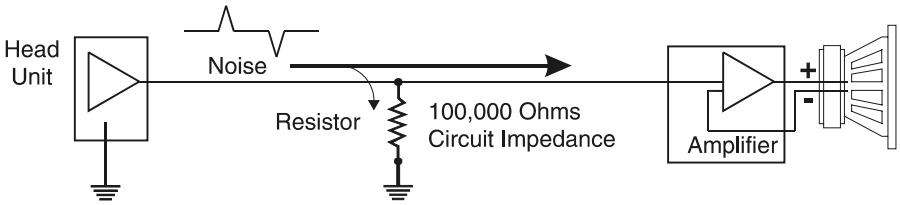

### Low Impedance

When the Circuit impedance is low, noise travels easily through the resistor to ground instead of into the amp.

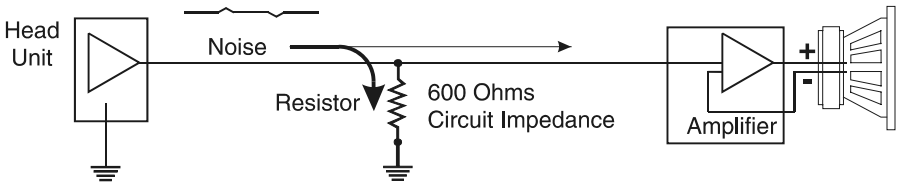

These drawings show how with low circuit impedance the noise is greatly reduced. For instance a 600 Ohm circuit impedance has approximately 166 times less noise than a 100,000 Ohm circuit impedance.

# Balanced or Unbalanced?

## Advantages

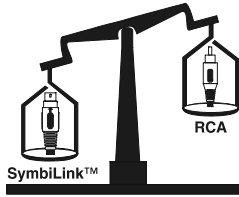

### **SymbiLink™** Balanced System

1. High noise rejection.
2. Higher audio signal level (16V).
3. Higher S/N ratio.
4. Improved stereo separation.
5. Improved T.H.D.
6. Low impedance (600 Ohms).
7. Easier to install, and cables can be run anywhere.
8. Less expensive than high-end RCA cables.

### **RCA** Unbalanced System

1. Widely used and readily available.
2. The average customer and installer is more familiar with RCA type cables.

## Disadvantages

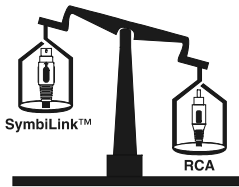

### **SymbiLink™** Balanced System

1. Limited availability.
2. Most customers and installers are used to using RCA cables.

### **RCA** Unbalanced System

1. Poor noise rejection.
2. Typically low audio signals (< 5V).
3. Lower S/N ratio.
4. Susceptible to Non-linear distortion.
5. RCA cables can pick up alternator whine if by noise radiating wires or equipment.
6. High impedance (20-100K).
7. Poorer stereo separation.
8. Even most high-end RCA cables will usually pick up radiated noise.

# SymbiLink™ Cables and Adapters

The SymbiLink™ cable and adapters come in various sizes and configurations to fit most uses.

## SymbiLink™ cable Lengths

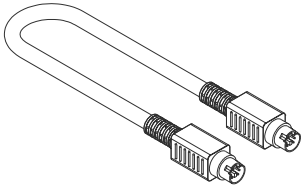

- .01 - .5 meter
- .03 - 1 meter
- .06 - 2 meter
- .12 - 4 meter
- .18 - 6 meter

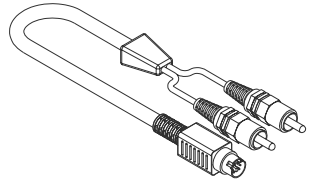

SLDIN cables between SymbiLink™ components.

SLRCM cables between SymbiLink™ and RCA units.

## SymbiLink™ Adapters

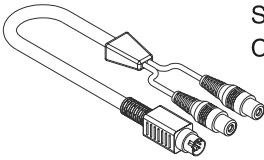

SLRCF.01 Adapts a male RCA Cable to a SymbiLink™ input.

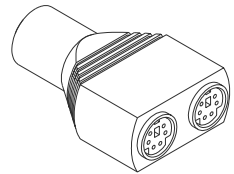

SLDIN.Y Adapts two SymbiLink™ cables to a single end.

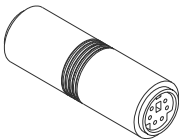

SLDIN.FTF Connects two SymbiLink™ cables together for extra length.

SLDIN.INV Swaps Right channel to Left channel for Mono use in custom installations.

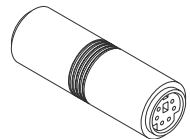

## Cable Connector End View

**Female  
P.C.B.  
Connector**

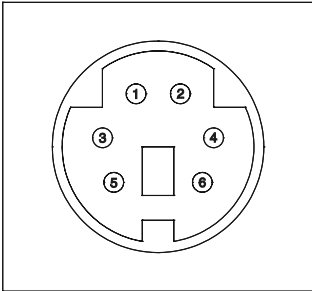

**Front View**

**Male  
Cable  
Connector**

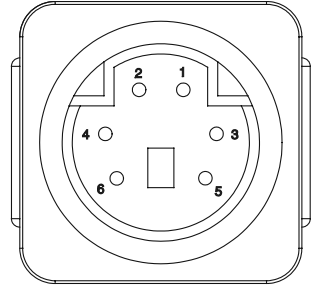

**Front View**

### **Cable pinout and color code**

**Pin # 1 (vop -) - Green**

**Pin # 2 (vop +) - Blue**

**Pin # 3 (Left -) - Yellow**

**Pin # 4 (Right -) - Black**

**Pin # 5 (Left +) - White**

**Pin # 6 (Right +) - Red**

**Shields - Bare**

**Right and Left ch. Shields terminate to  
metal body of Din connectors**

## SLB-TP4

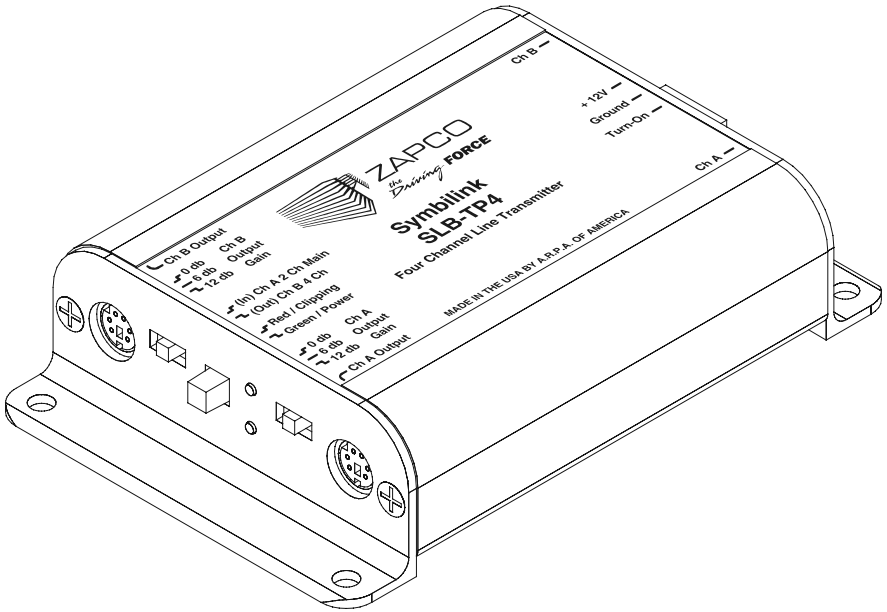

A number of years ago, Zapco introduced the worlds first, widely accepted, balanced line system for the car. The SymbiLink™ Balanced Line Transmitter, or SLB-T.

The newest generation of Zapco's transmitter is the SLB-TP4. Recognizing that many modern car systems use a separate amplifier for the woofer, Zapco redesigned the transmitter to allow two separate balanced lines from a single chassis.

The SLB-TP4 has two sets of RCA inputs on one side and two sets of SymbiLink™ balanced outputs on the other. The SLB-TP4 also has independent gain settings for each set of outputs at 0, +6dB, or +12dB.

To assure maximum versatility, we have also provided an input switch to give you the choice of using one set of inputs to feed both sets of outputs. (Maximum sonic performance with the SymbiLink™ system is best achieved by placing the first processor in line as close to the source, **by signal cable run**, as possible).

## SLB-R / SLB-R4

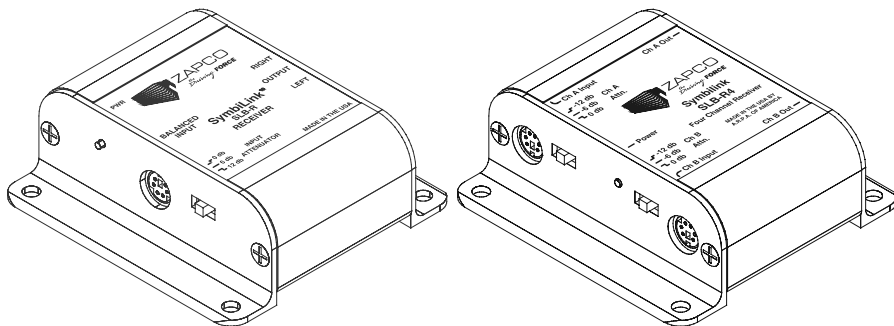

To allow audiophile signal transmission with non-SymbiLink™ amplifiers, Zapco has two SymbiLink™ receivers available.

The first is the SLB-R. The SLB-R provides a SymbiLink™ Balanced input to receive the high voltage, noise free signal from the transmitter, and a set of RCA outputs to go to an unbalanced amplifier input stage. It also provides signal attenuation so you can match the signal to your individual amplifier's input level.

The second receiver is the SLB-R4, which consists of two SLB-R receivers in a single chassis. The SLB-R4 allows the system to drive two amplifiers from a single receiver and still maintain any fading functions.

## SLB-U

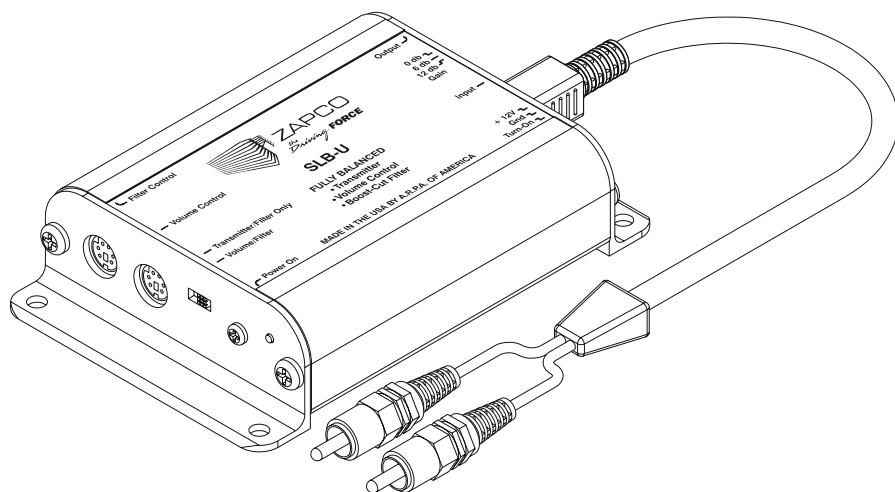

The SLB-U is the most versatile of the SymbiLink™ units. The basic unit is a differentially balanced signal input stage combined with a line driver capable of adding up to 12 dB of gain to any standard RCA signal input. The end result is that the SLB-U will convert a standard, high impedance RCA input to a low impedance, high voltage balanced output.

The SLB-U also offers provisions for expanding your system with two options:

First, a VFM cable (see following page) can be added to the SLB-U. This will turn the unit into a volume control as well as a transmitter. You need only plug the cable and knob into the port on the SLB-U and you will be able to control your amp volume remotely.

Your second option with the SLB-U is to add an SX Filter Module and a second VFM cable/knob. Now you will have a single band,  $\pm 18\text{dB}$ , equalizer. This is the perfect combination for controlling a bass amp.

NOTE: The SLB-U comes with a power input plug for use with non-SymbiLink™ amps (which we will cover later). If you are using it with a SymbiLink™ amp, the SymbiLink™ cable will provide power. The external plug is not needed.

(Maximum sonic performance with the SymbiLink™ system is best achieved by placing the first processor in line as close to the source, **by signal cable run**, as possible).



## VFM.CBL

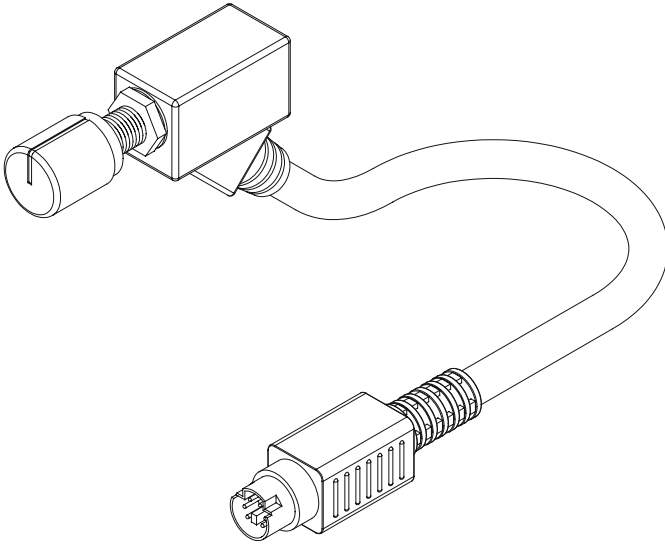

The VFM cable is a potentiometer that may be used in two ways with the SLB-U.

First, you can convert any SLB-U to operate as a volume control as well as a SymbiLink™ Transmitter. Simply plug the cable into the appropriate DIN receptacle and put the mode switch into Volume / Filter position. You now have a remote volume control for any amp hooked to the SLB-U.

Second, another VFM cable will also allow you to use the SLB-U as a single frequency equalizer. Plug in the cable, plug in the filter chip, and you now have the industry's best bass amp control.

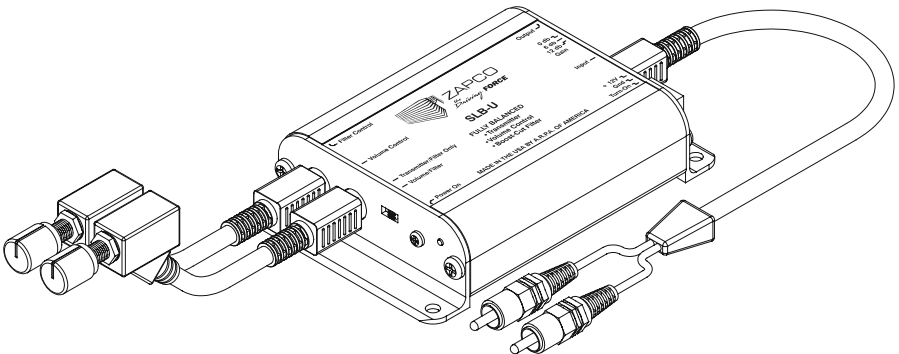

# SLB-U Endplates

## Power Endplate

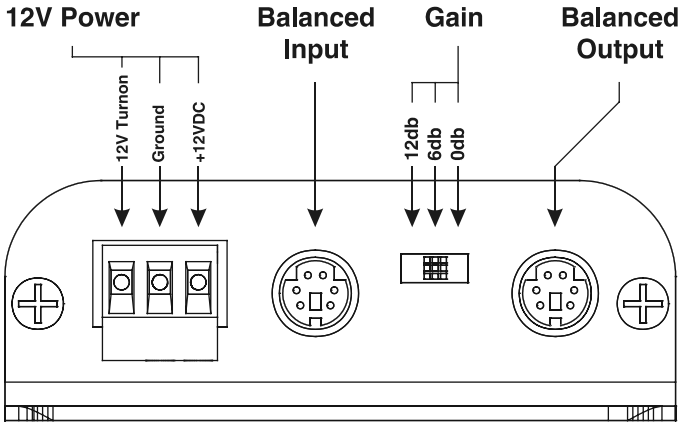

## Control Endplate

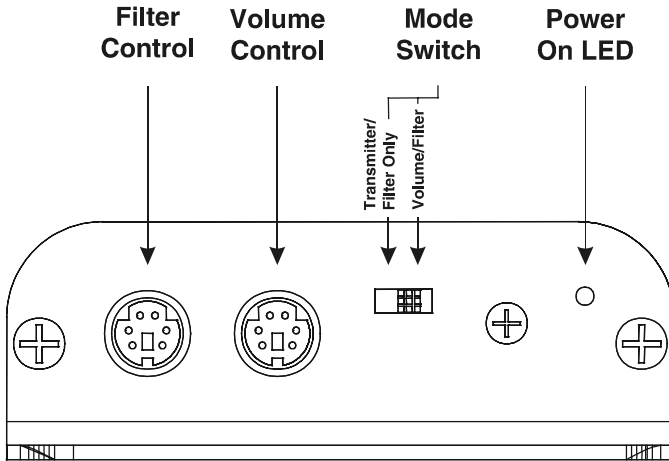

### Caution!!

Do not plug SymbiLink™ power into Control Endplate Filter and Volume Control receptacles. Doing so will cause permanent damage to your SLB-U.

## SLB-U Setup Table

	Function Switch	Filter Control	Volume Control	Frequency Module Installed
<b>Volume Only</b>	<b>Volume/Filter</b>	<b>NO</b>	<b>YES</b>	<b>NO</b>
<b>Filter Only</b>	<b>Filter Only</b>	<b>YES</b>	<b>N/A</b>	<b>YES</b>
<b>Volume/Filter</b>	<b>Volume/Filter</b>	<b>YES</b>	<b>YES</b>	<b>YES</b>

Each SLB-U can be powered by SymbiLink™ power or by an external 12 VDC supply. The following conditions warrant powering the SLB-U with an external 12 VDC supply:

1. More than 10 SLB-U in one chain.
2. More than 3 SLB-U and 2 other SymbiLink™ units (EQ, X-over, Noisegate).
3. More than 5 SLB-U and 1 other SymbiLink™ unit.

**The SLB-U's internal power supply cannot power any external SymbiLink™ unit.**

## SX-SL Modules

There are over 120 different filter modules available for the SLB-U. To get to the filter module header, remove the two endplate screws on the control endplate and slide out the endplate-circuit board assembly.

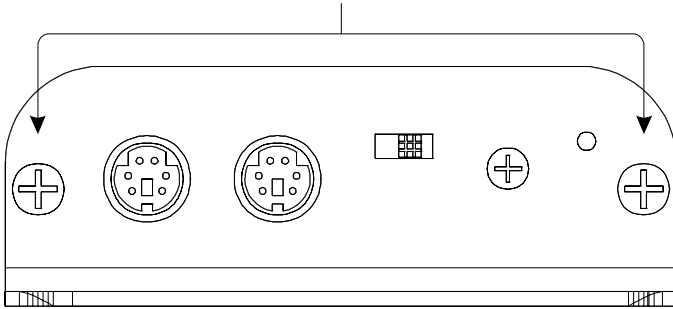

The module must be inserted onto the 8-pin header as is shown in the diagram below. The parts on the module will vary from module to module, but the circuit board must face towards the endplate.

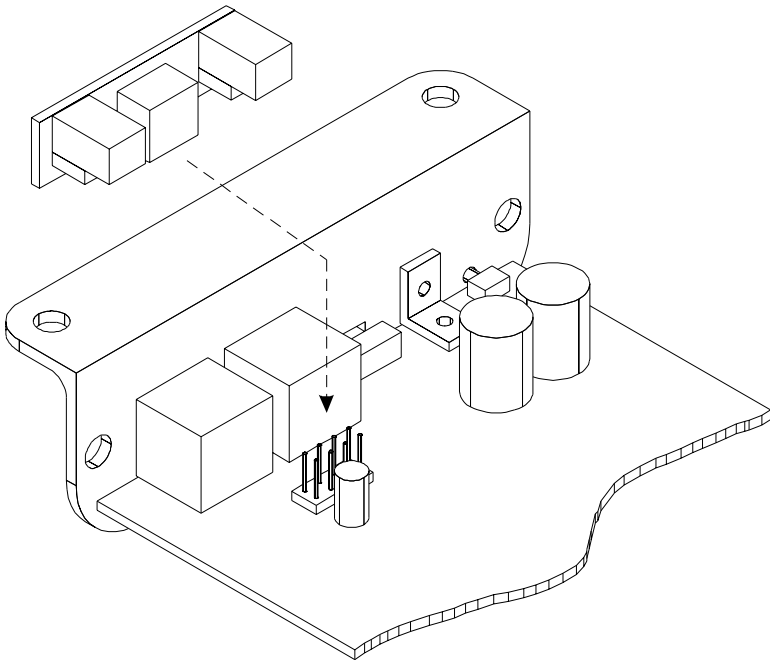

# SymbiLink™ Specifications

Model	SLB-U	SLB-TP4
T.H.D	<.005%	<.002%
S/N Ratio	>100 dB	>100 dB
Separation	>80 dB	>85 dB
Freq. Response	1 - 30kHz +0/-3 dB	1 - 30kHz +0/-3 dB
Gain	0, 6, or 12dB	0, 6, or 12dB
Input Sensitivity	.25 - 16 Volts	.25 - 8 Volts
Output Level	.5 - 14 Volts	.5 - 16Volts
Input Impedance	10K ohm	20K ohm
Output Impedance	600 ohm	600 ohm
Dimensions (h,w,l)	1.18" x 3.6" x 5.4"	1.18" x 3.6" x 5.4"

Model	SLB-R	SLB-R4
T.H.D	<.002%	<.002%
S/N Ratio	>100 dB	>100 dB
Separation	>85 dB	>85 dB
Freq. Response	1 - 30kHz +0/-3 dB	1 - 30kHz +0/-3 dB
Gain	0, 6, or 12dB	0, 6, or 12dB
Input Sensitivity	2 - 16 Volts	2 - 16 Volts
Output Level	.25 - 8 Volts	.25 - 8 Volts
Input Impedance	10K ohm	10K ohm
Output Impedance	600 ohm	600 ohm
Dimensions (h,w,l)	1.18" x 3.6" x 3.4"	1.18" x 3.6" x 3.4"

# PSI-HPSL

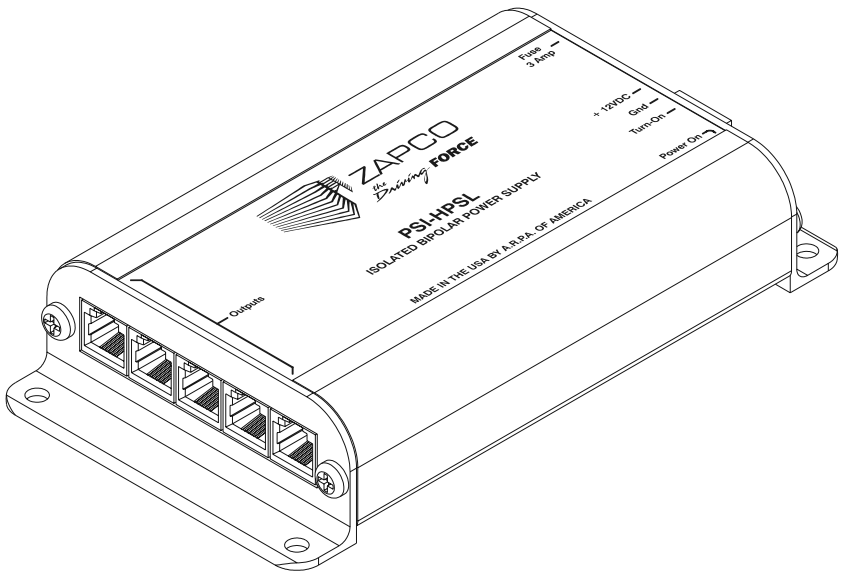

Internal power supplies are by far the most common source of noise in signal processors. ARPA of America has eliminated this problem in its Zapco products by adapting the SymbiLink™ balanced line system. We use the  $\pm 15\text{V}$  wire pair in the SymbiLink™ cable to provide “phantom” power for our signal processors. They draw their power directly from any SymbiLink™ equipped amplifier. With no internal power supply, the Zapco processors are the quietest on the market.

The PSI-HPSL is a 15V power supply used in system applications in which SymbiLink™ processors are being used with non-SymbiLink™ amplifiers. It is also used in systems in which Zapco EQ30-SL's and/or a DAIL-SL is used or in a system for which three or more SymbiLink™ processors are being used. A single power supply can power up to five SymbiLink™ processors and two SymbiLink™ receivers.

Installation of the PSI-HPSL requires providing 12V constant power, remote turn-on, and ground. A 3 amp fuse is used to protect the PSI-HPSL from being overloaded. If this fuse pops more than once, there may be too much of a load being placed on the PSI-HPSL.

A single PSI cable (PSI.CBL) is provided in the box with a new PSI-HPSL. Additional PSI.CBL's can be ordered through the closest authorized Zapco dealer.

# SLB-U as a Transmitter

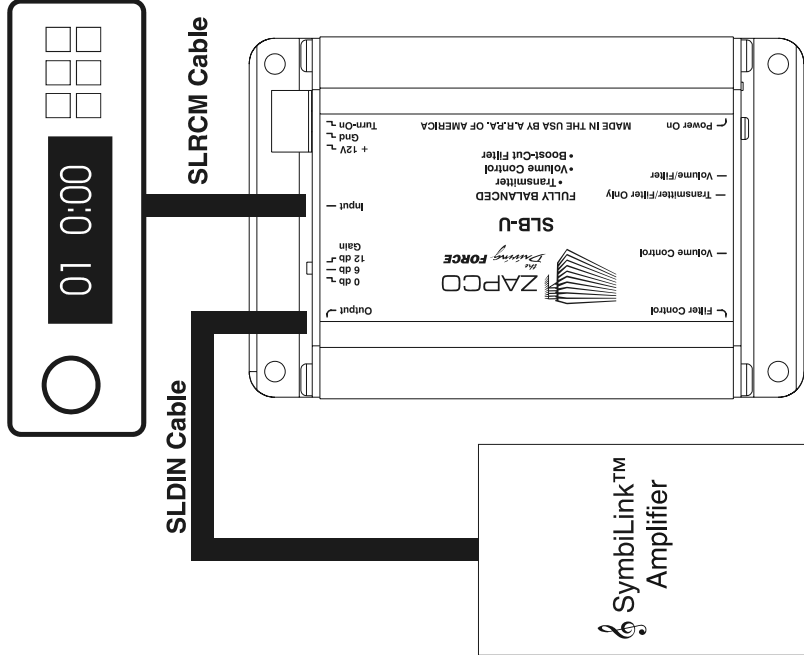

## System Drawings

# Volume Control Only with SymbiLink™ Amp

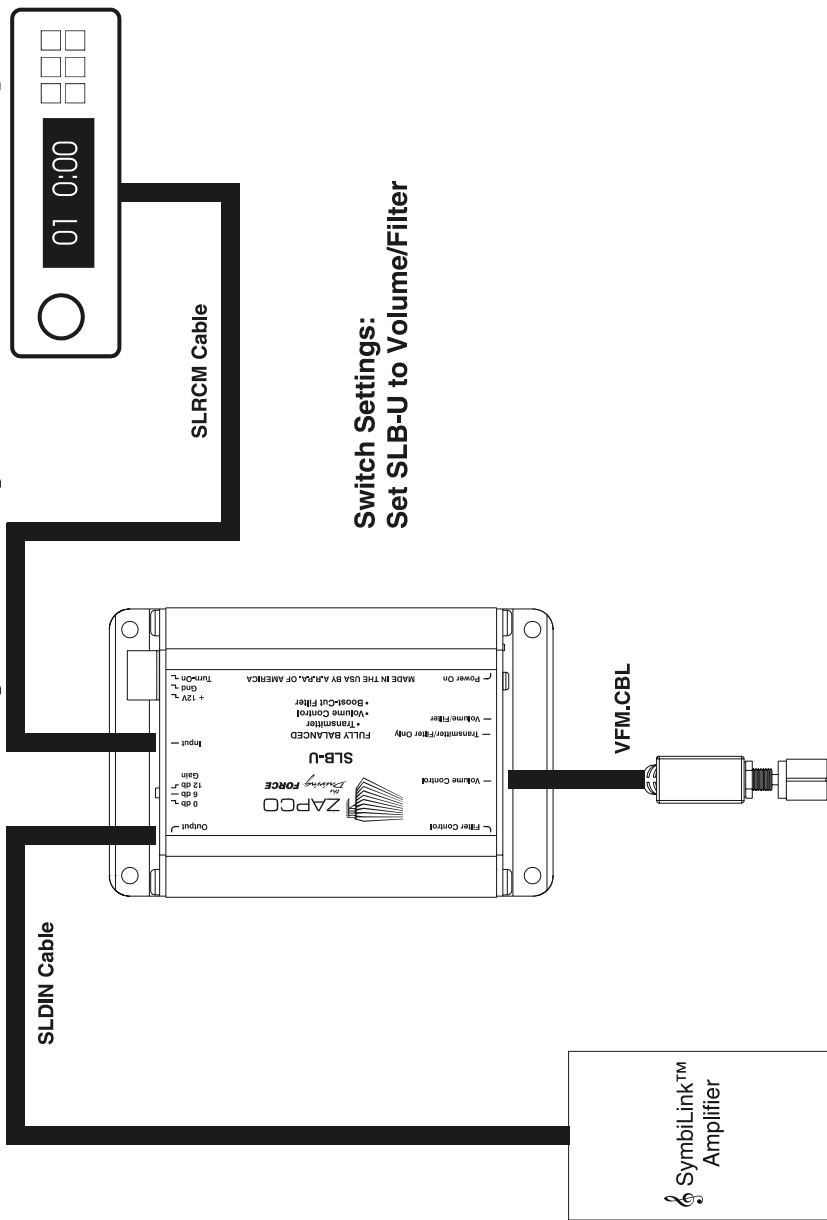

**Switch Settings:  
Set SLB-U to Volume/Filter**



# Boost/Cut Filter Only with SymbiLink™ Amp

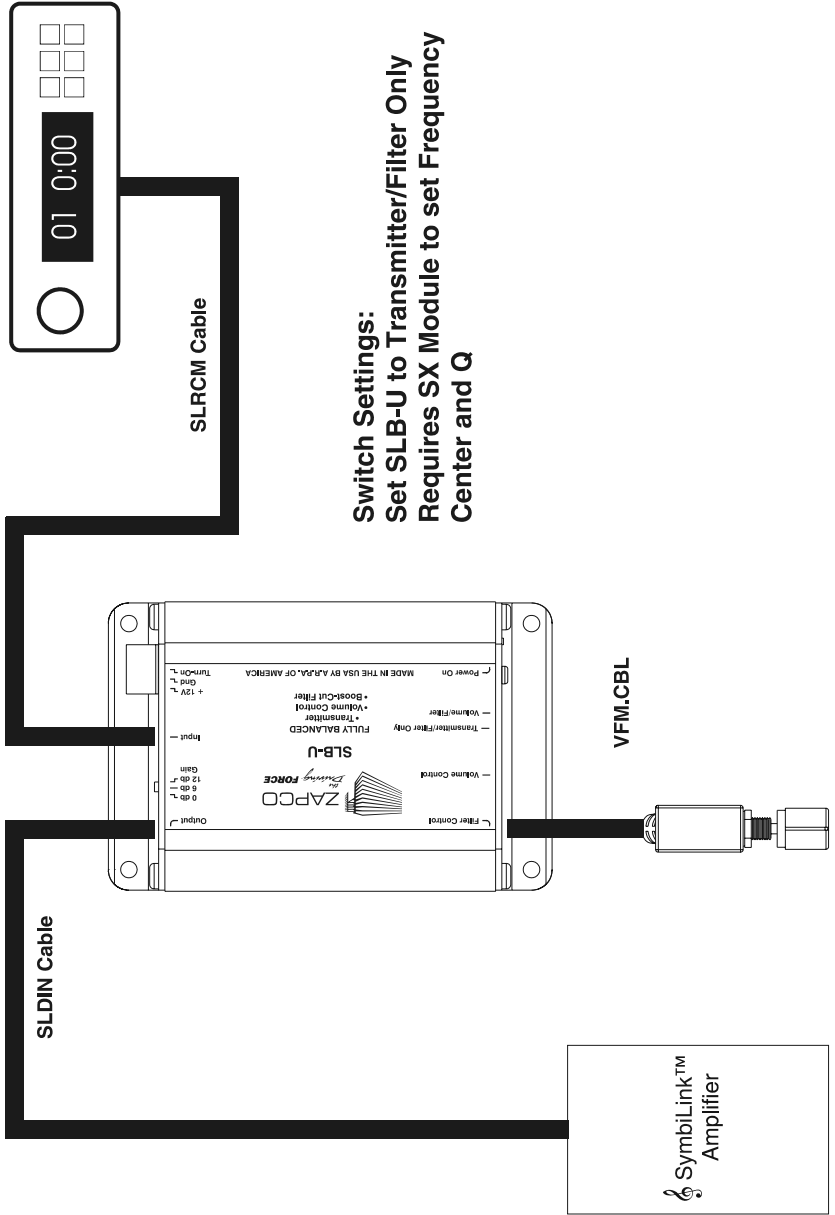

**Switch Settings:**  
**Set SLB-U to Transmitter/Filter Only**  
**Requires SX Module to set Frequency Center and Q**

# Volume Control Only with Non-SymbiLink™ Amp

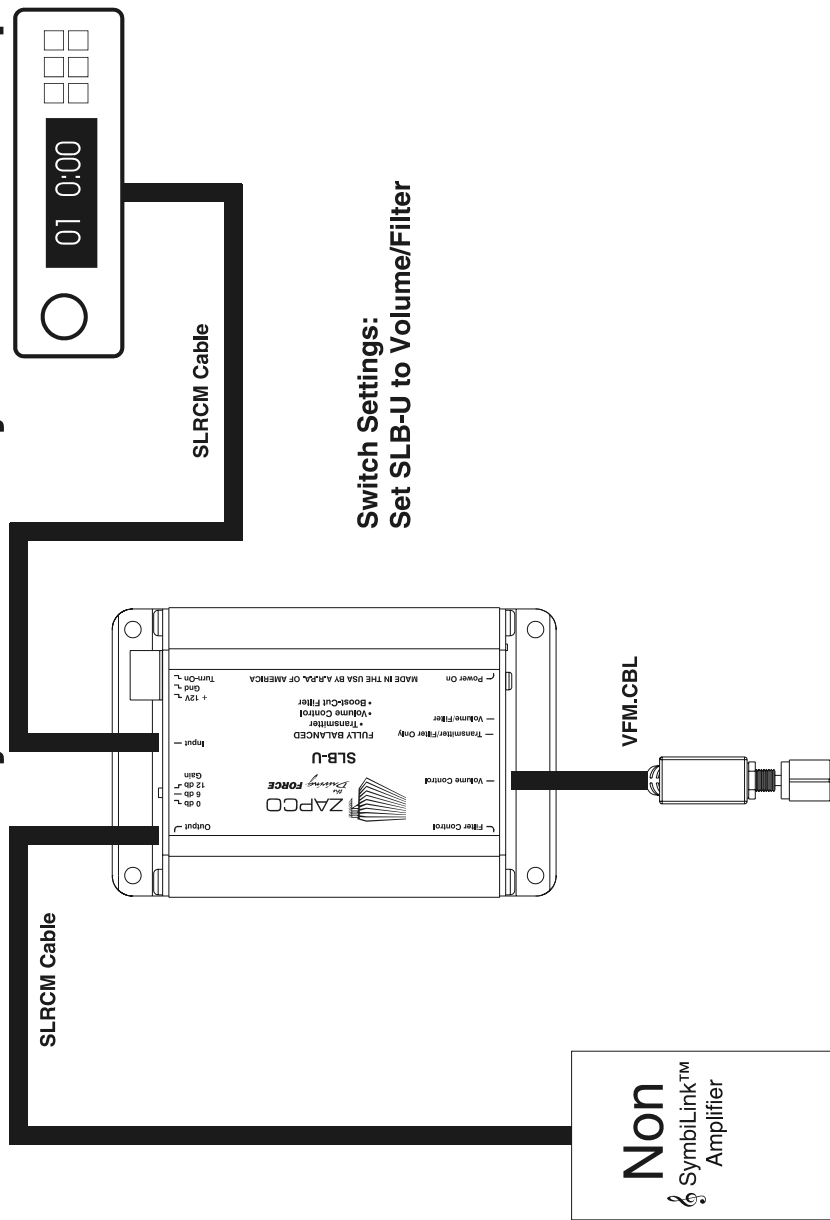

# Volume and Filter Control

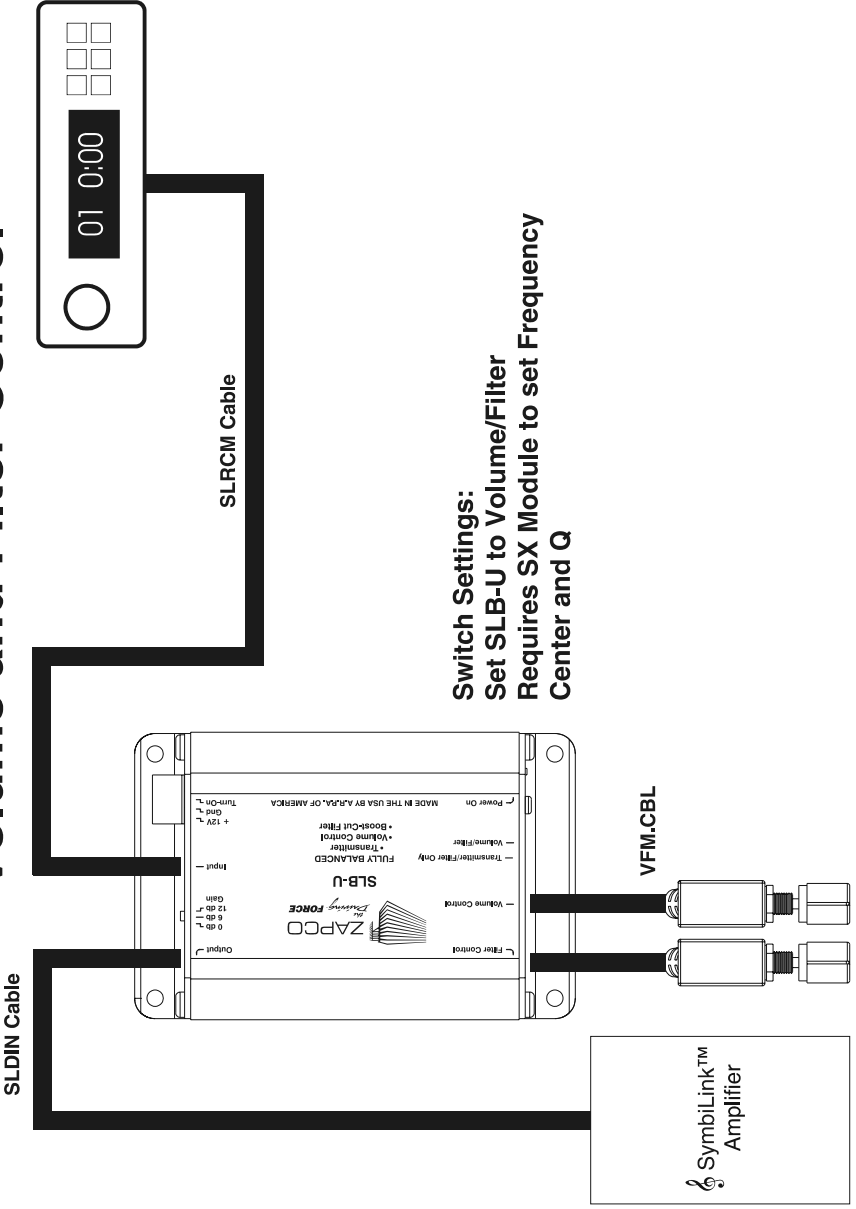

**Switch Settings:**  
 Set SLB-U to Volume/Filter  
 Requires SX Module to set Frequency  
 Center and Q

# Boost/Cut Filter Only with Non-SymbolLink™ Amp

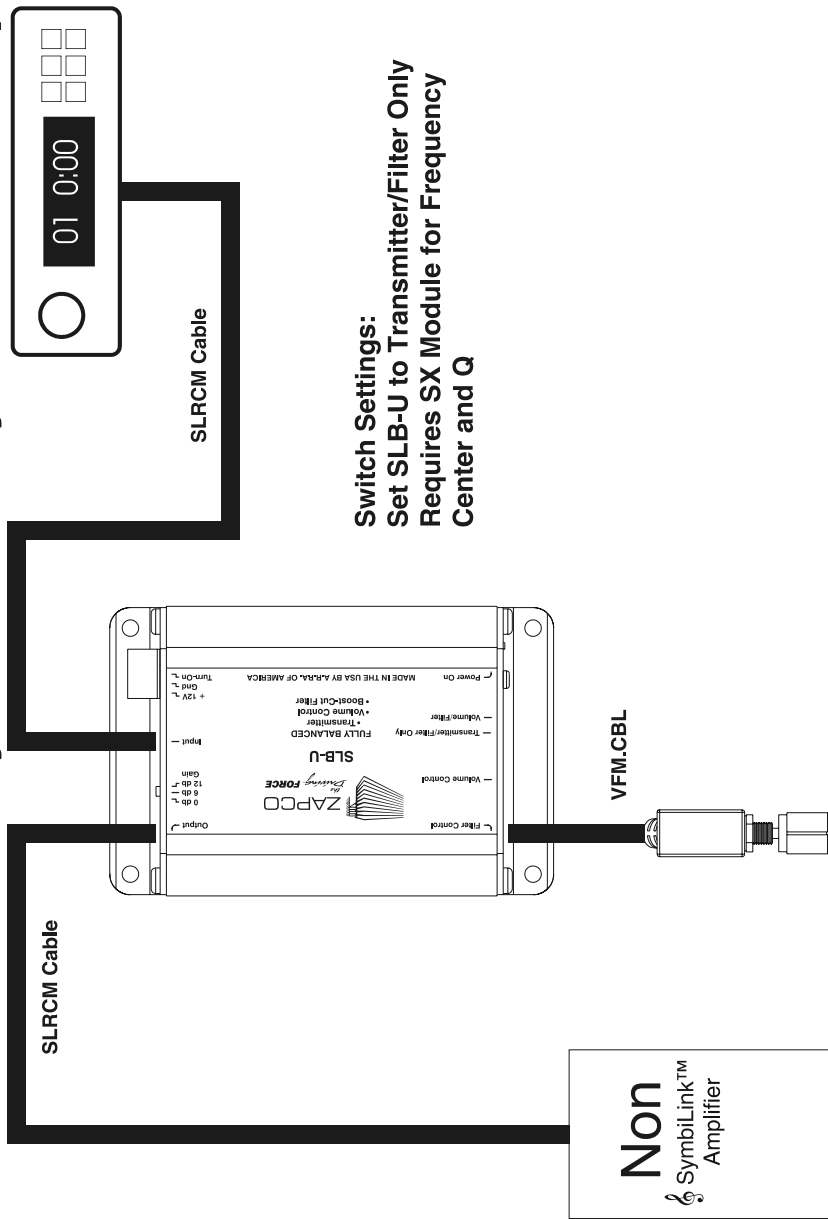

**Switch Settings:**  
Set SLB-U to Transmitter/Filter Only  
Requires SX Module for Frequency  
Center and Q

# Master Volume / Mid Hi Eq / Bass Volume

SLB-U (A) requires a SX Filter Module with a frequency of 160, (Ideal for Kick Panel mounted speakers)

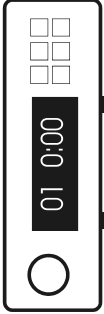

Switch Settings:  
Set all SLB-U's to Volume/Filter

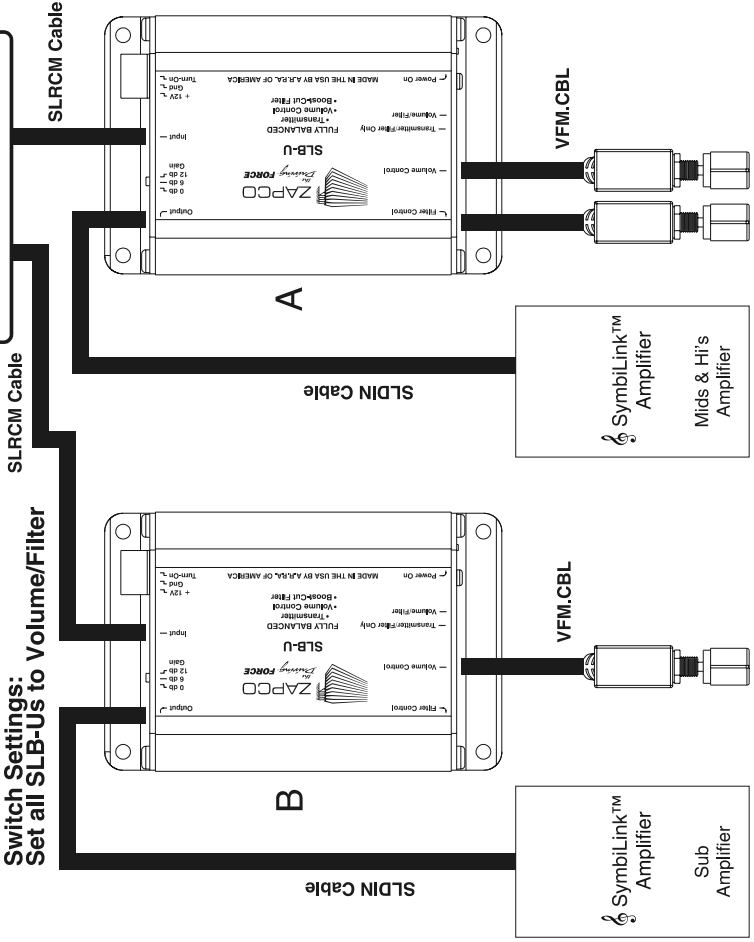

# Subwoofer Control for Non-SymbiLink™ Amplifier

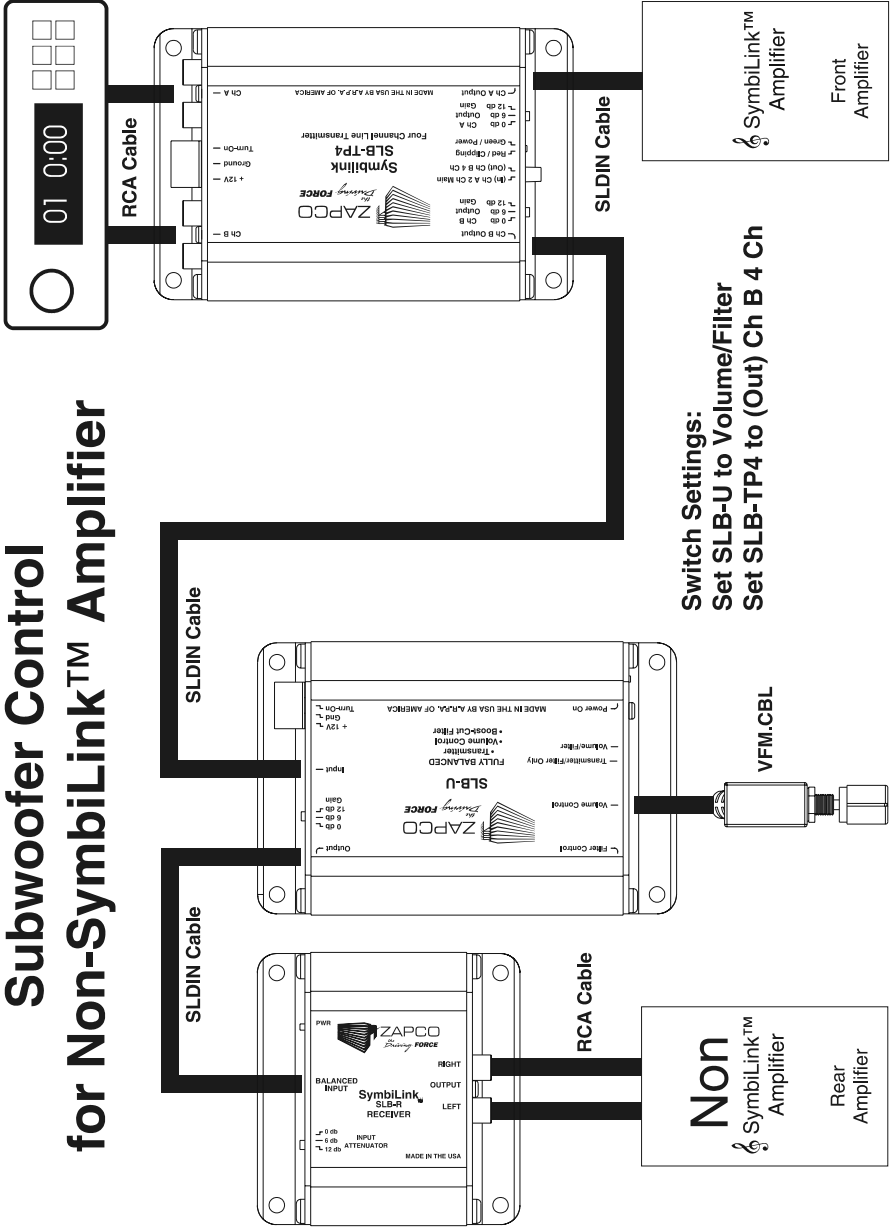

**Switch Settings:**  
 Set SLB-U to Volume/Filter  
 Set SLB-TP4 to (Out) Ch B 4 Ch

# Volume/Filter with Non-SymbiLink Amps

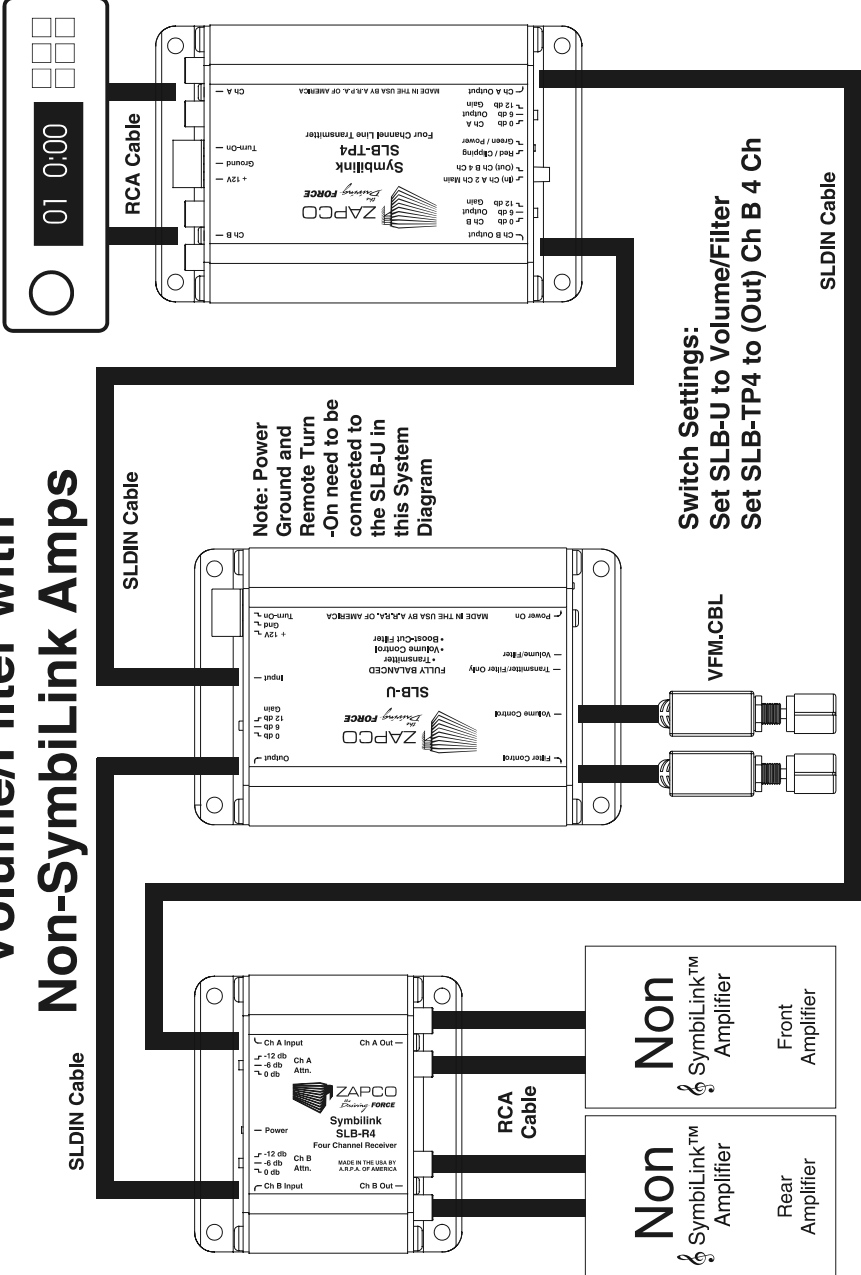

**Note: Power Ground and Remote Turn -On need to be connected to the SLB-U in this System Diagram**

**Switch Settings:  
Set SLB-U to Volume/Filter  
Set SLB-TP4 to (Out) Ch B 4 Ch**

# Upfront Amp Volume Control

**Switch Settings:**  
Set all SLB-U's to Volume/Filter

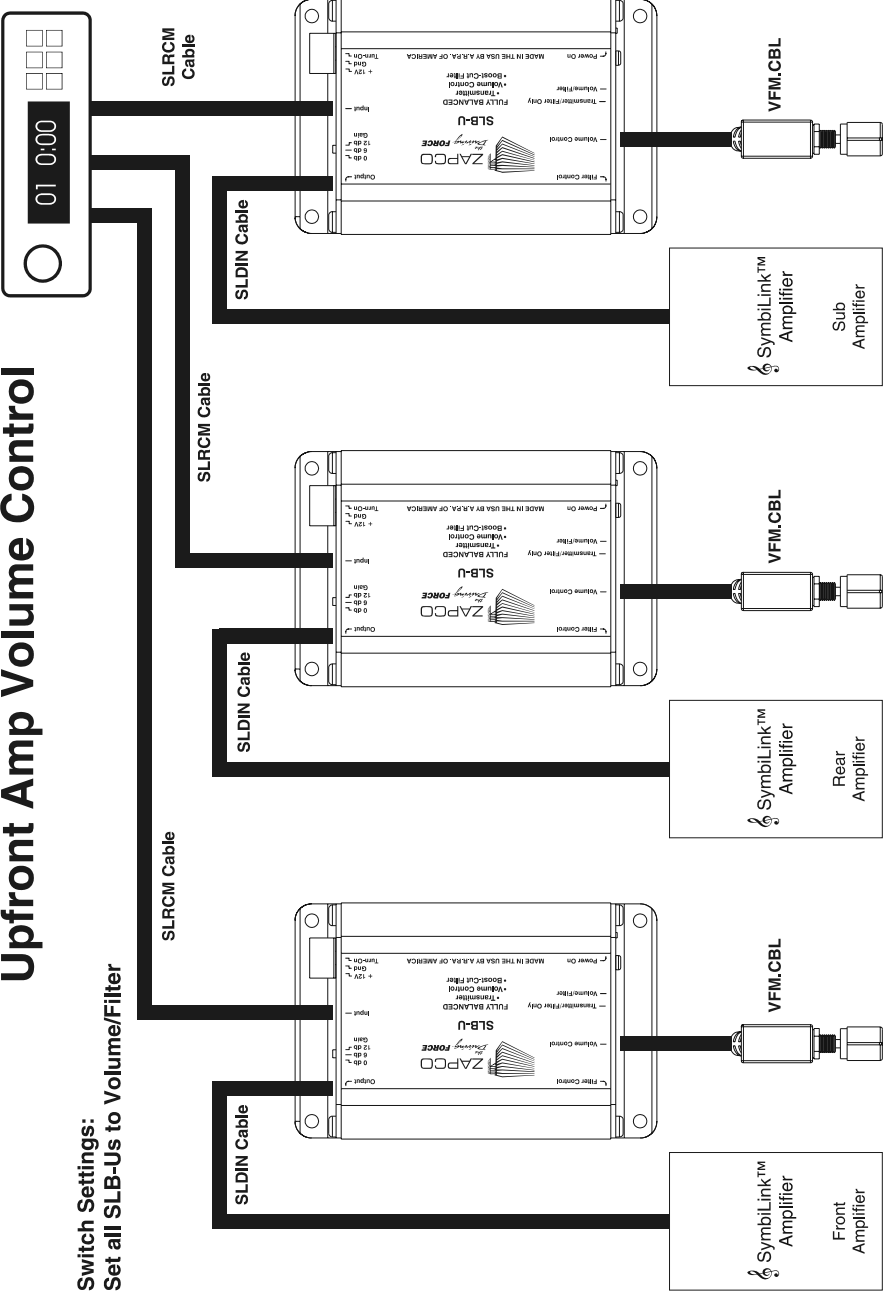



# SP7-SL with Dedicated Bass Volume

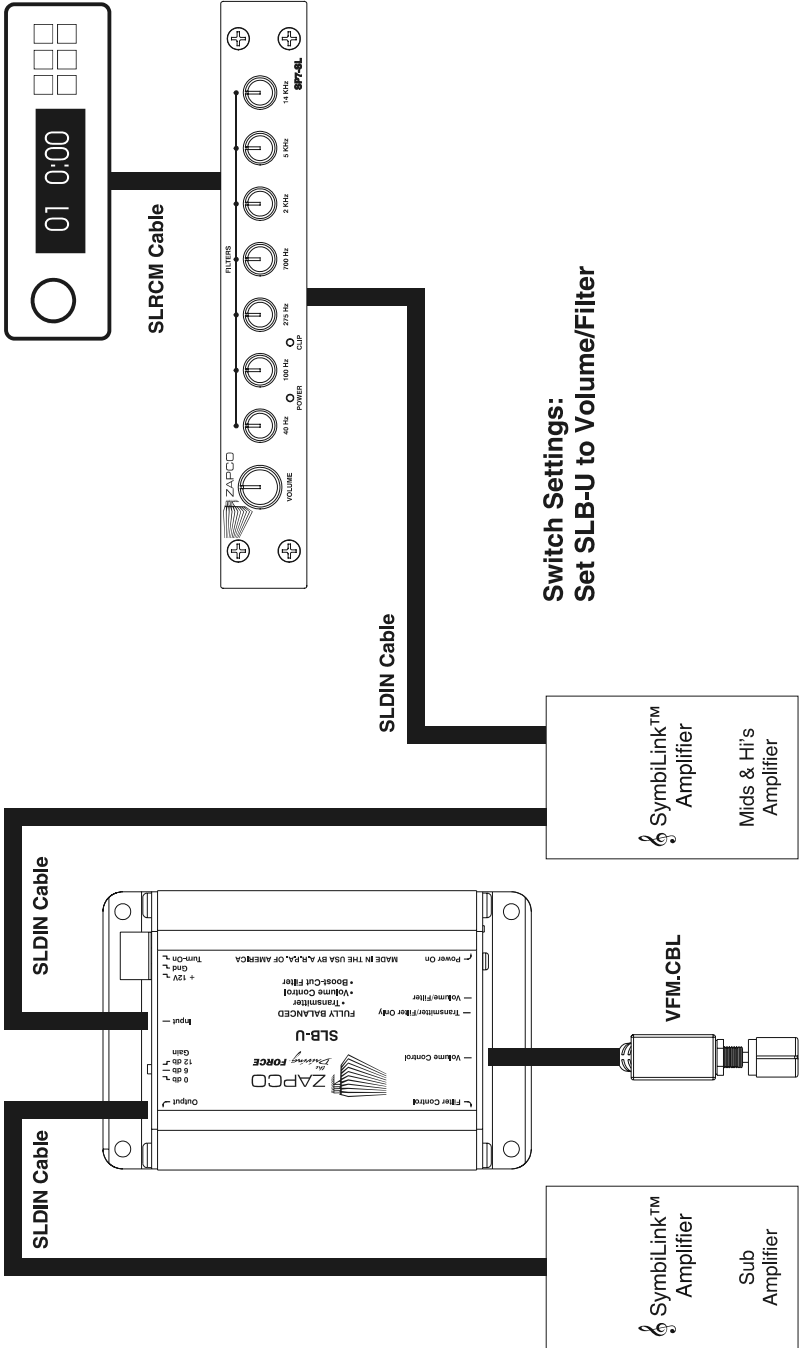

# Dedicated Sub Volume Control for SP7-SL

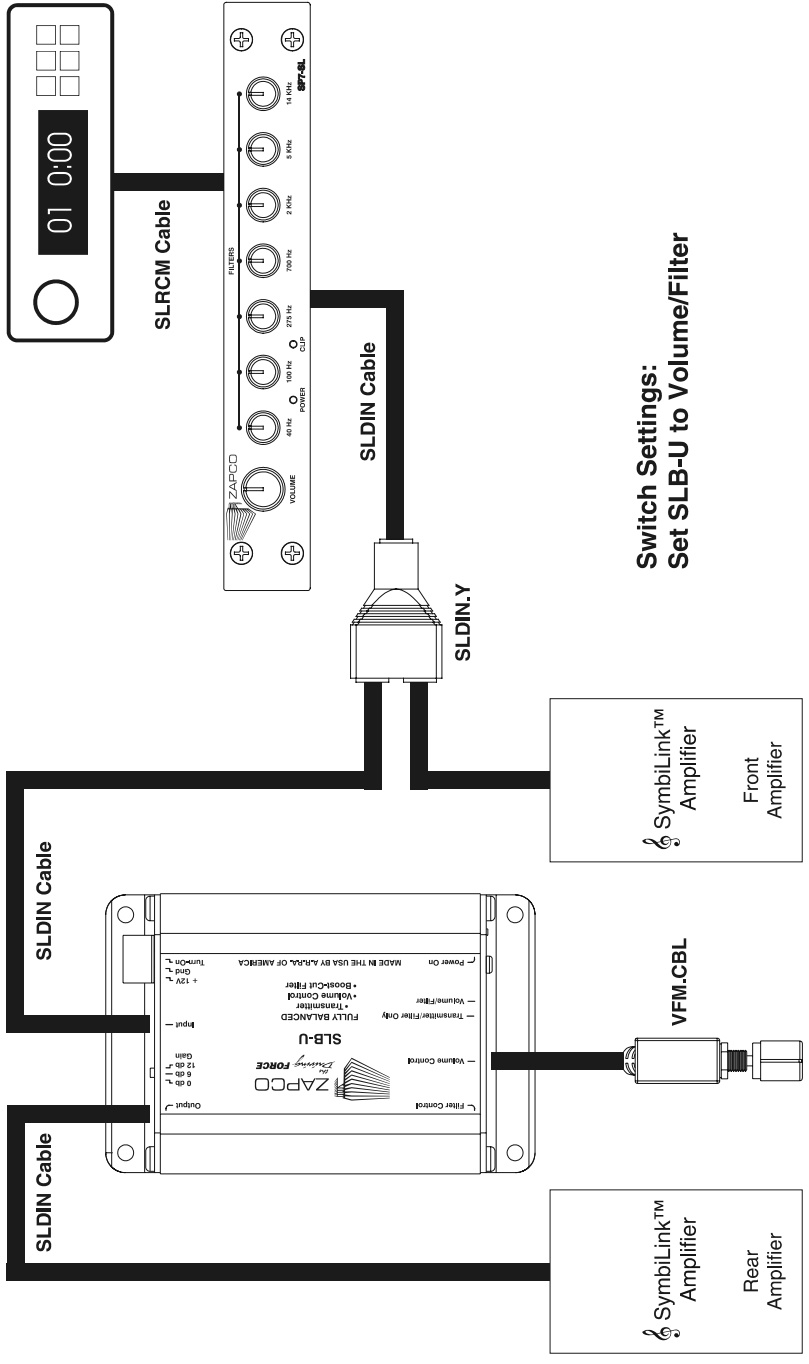

**Switch Settings:  
Set SLB-U to Volume/Filter**

# SLB-TP4, 2Ch Input, 4Ch Output

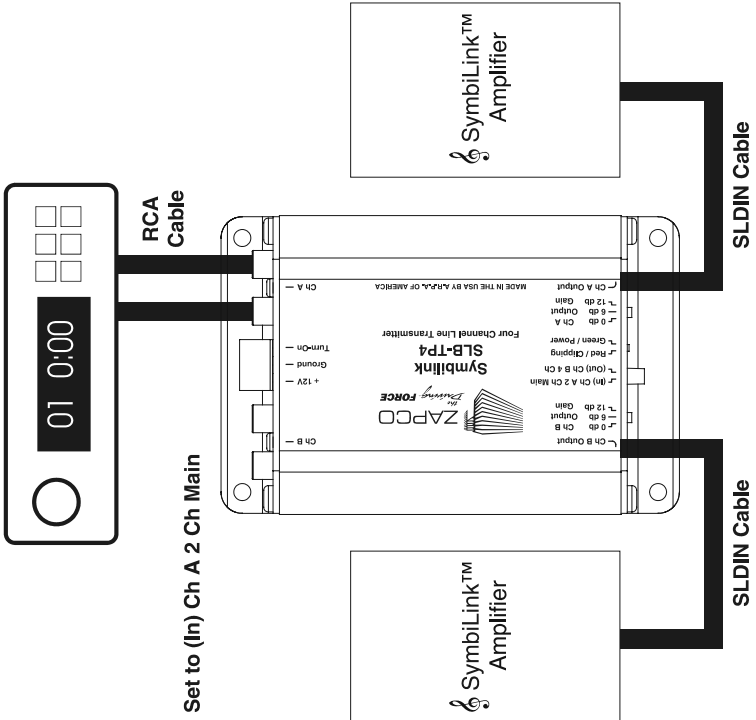

# SX-SL with SLB-R and SLB-R4

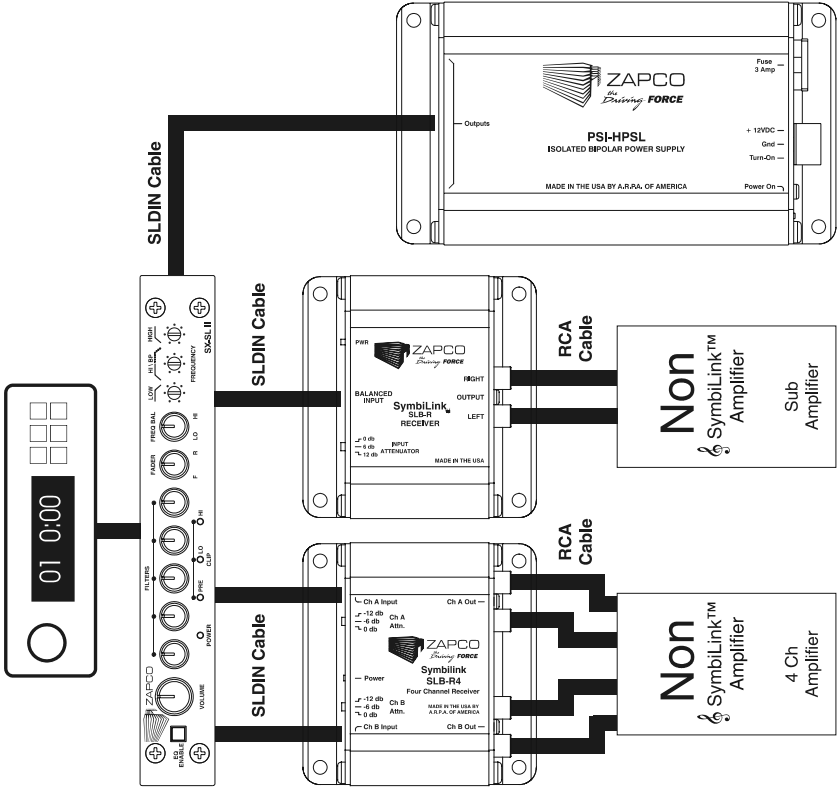

## Technical Assistance

Should you experience a problem with your SymbiLink™ product, please contact the dealer that sold you this product. If your dealer is unable to solve your problem, you may contact the factory service department directly.

Phone: (209) 577-4268 Monday - Friday, 8AM - 5PM Pacific Time  
FAX: (209) 577-8548

Also, check our web page, [www.zapco.com](http://www.zapco.com), for tips. You can also e-mail technical help directly from our web page or [engineer@zapco.com](mailto:engineer@zapco.com).

If you need to return this product for repair, please call the factory for a Return Materials Authorization (RMA) number. We will ask you for information that will include your name, return shipping address, daytime phone number, model and serial number, and a detailed description of your problem. A photocopy of your original purchase receipt is necessary to determine warranty status and should also be included. Once we issue you an RMA, please write it in a highly visible area on the package. Zapco will not accept any packages that do not have a valid RMA number clearly marked on the outside of the package.

Once you have a valid RMA number, send all repairs to:

A.R.P.A. of America Corp.  
Attn.: Service Department  
413 S. Riverside Drive  
Suite D  
Modesto, California, 95354



**SymbiLink™**

***A.R.P.A. of America Corp.  
413 S. Riverside Drive, Suite D  
Modesto, CA 95354  
(209) 577-4268  
Fax (209) 577-8548***

***Rev. A  
02/02***