

# HDSP-V AD-A (DCP v.2.9.2) Owner's Manual

Before operating the unit, please read this manual thoroughly and retain it for future reference.

Last update November 8, 2019

# MISSION STATEMENT

## Committed to Excellence

*ZAPCO is dedicated to the pursuit of audio fidelity. Our prime objectives are to design and manufacture audio products of unsurpassed quality, to provide unparalleled support and service for these products and to conduct business in a manner that will enhance the quality of life for all involved.*

## Experience (Knowledge from doing)

*There is absolutely no substitute for experience; that is a simple fact of life. Another simple fact is that ZAPCO has, for over forty years, been the leader in defining quality standards for the car audio industry. These years of experience have led to a thorough understanding of the challenges that are unique to the world of car audio. ZAPCO's relentless quest for sonic purity consistently yields imaginative designs that utilize the most innovative technologies. The resulting products set the criteria by which all others in the industry are judged.*

# Table of Contents

<b>Introduction</b> .....	4
<i>The revolutionary Zapco HDSP-V Series</i> .....	4
<i>Bar raising numbers for the Zapco HDSP-V</i> .....	5
<i>Upgradable internal modules/components</i> .....	7
<b>HDSP-V PAD-A Input End</b> .....	8
<b>HDSP-V PAD-A Output End and Dash Board</b> .....	9
<b>HDSP-V PAD-A Cover Plate</b> .....	10
<b>Installing the Control Program (GUI)</b> .....	11
<b>Unit Installation</b> .....	13
12V Connections .....	13
Input Sensitivity for Radio/CD Head Unit .....	14
<b>Opening the Control Program (GUI)</b> .....	15
<b>The HDSP-Z16 V Control Program</b> .....	17
The Main Page .....	17
The I/O Page .....	22
Defining Outputs .....	22
Defining Inputs .....	23
Auto-Summing .....	25
The Delay Page .....	26
The Crossover Page .....	28
The Phase Page .....	30
The VSEQ Page .....	32
The Equalizer .....	33
<b>Speaker Polarity and Phasing</b> .....	36
<b>Tuning - The Simple Rules</b> .....	37
<b>Dash Board Control</b> .....	39
<b>Formatting Larger USB Thumb Drives/Sticks</b> .....	42
<b>HD Player Quick Start</b> .....	43
<b>Special Features of the HDSP-Z16 V Processor</b> .....	43
Ambient Rear Fill .....	43
Creating a Pair of 60-Band Equalizer Channels .....	45
<b>Firmware Update</b> .....	47
<b>Technical Specifications</b> .....	49

## The revolutionary Zapco HDSP-V Series



*From Italy finally comes a masterpiece of engineering that will mark the history of Zapco with a fundamental step from the analog to the digital world, with everything at the highest levels possible today in the high-end audio world. It was made for the car, but the performances are so extraordinary that it's a unique product to use even at home as it can hold up to comparison with home audio products, which have significantly higher prices.*

*The new HDSP-V is finally available in its 16 and 8 channel versions. Long-awaited, it has required an incredibly long work for the development of firmware, software, and hardware. Six Master Engineers have worked for 3 years on this project with over 15,000 hours of activity. It has been developed for performance that will set entirely new standards. The noise floor of this device reaches -140 dB (noise plane without input signal). In the 192 KHz version with player or with digital inputs, the S/N of the analog outputs is equal to 115 dB in the basic version, or over 130 dB with the DAC A option.*

*The HDSP-V has only one chipset that integrates two processors that work up to 64 bits and 456 MHz (for a total of 912 MHz), both for the management of the Player and the DSP. The Player is therefore completely integrated into the DSP itself. This guarantees the Player a total absence of connection problems and the transmission of the signal, from the Player's processor to the DSP's processor, within the same chipset. All up to 192 KHz for a signal line that can reach the new digital Z-AP amplifiers (coming next year) through an optical SPDIF connection.*

*The possibilities of connection of the HDSP-V are with its dash remote control or with Wi-fi connection. HD Bluetooth streaming is possible thanks to the optional module.*

Vincenzo Biasella  
President  
APEX & Zapco

# Bar raising numbers for the Zapco HDSP-V

The HDSP-V is the best hardware that Zapco has ever built, and the numbers attest to that. Although the HDSP is composed of 18 individual pieces (HDSP-Z16V) put together in a modular version that is easy to adapt or update according to your needs, the background noise and the crosstalk numbers are superb. The end result surpassed even the expectations of the designers and engineers who built it. The numbers are the proof of the design, for example **-140 dB of background noise** and **-115 dB of crosstalk**. For a 16-channel device, crosstalk at -115 dB (average around 1 KHz) is proof of the accuracy with which the layout was made. The digital inputs have 114 dB of A weighted signal/noise and the analog inputs have 109 dB at rated output. We kept the output voltage at 4 Volts to avoid added distortion of analog preamplification. Distortion of analog and digital inputs are lower than 0.001% at 4 Volt output and lower than 0.00175% at 1 Volt output. The HDSP-V power supply continues to work down to 6 Volts to solve the problem of cars that have the stop-start ignition system. The main processor is a dual core 456 + 456 MHz, 8 and 16 channels solution have a 192 and 96 KHz sampling rate and the converters are new 32 bit/784 KHz devices from AKM. Very importantly, it is an HD Player that works at 24 bit/192 KHz integrated with DSP. There is no connection between the Player and the DSP, no PCB, no connectors, no cables. Player and DSP are integrated in one dual core chipset that has a total power of 912 MHz. Then there is a microprocessor that controls only the Player and does not have to do other heavy computational work like can happen, for example, with a computer. The player has a dedicated browser that starts to work immediately when you insert the USB memory stick. It can read all formats up to 24 bit/192 KHz, compressed or not compressed, and from the 3" touch screen display, you can control all the functions using 3 different levels of folders. The dash board that controls the Player also controls minor DSP functions and can manage up to 10 tuning presets with instantaneous switching of one to another for A/B comparison.

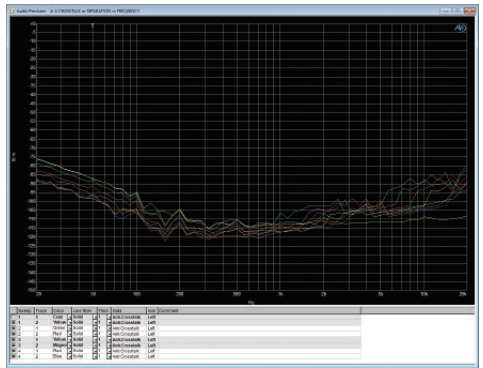
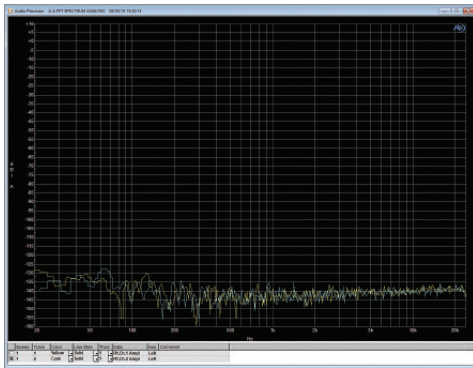

### **All-in-one Dual Core Processor - Why a Player with on-board DSP?**

Players (portable or not), often have a DSP inside, either simple or sophisticated, but it is a DSP. Zapco has been inspired by this to offer its customers a professional DSP with the Player inside. What are the advantages of our integrated solution compared to that of connecting a Player to the DSP? First, it must be said that not all portable players have a digital output. If analog, even if it's of excellent quality, it would always result in a degradation of quality due to the presence of two more converters on the signal path. Therefore a coupling of an external player to an analogue input is strongly inadvisable. If, on the other hand, the external player has a digital output, then the situation is much better, but still there is the limit of an SPDIF connection. The SPDIF protocol has a maximum resolution of 24 bits and a maximum sampling rate of 192 KHz. Another limitation of the SPDIF connection is that the receiver does not control the speed of data, so it is possible to have connection problems. In any case, the maximum integration of the two products, DSP and Player inside the same chipset, protects from any issues of connection whatever the nature of the problem may be.

### **High-End Solution: 18 independent PCB - Why Modular?**

The modularity of the apparatus offers considerable advantages. The first advantage is that the customer can request the product with the cards that he needs without having to buy what he does not need. Subsequently it is possible to easily up-grade a part of the product keeping all the rest unaltered. This allows to keep the value of the product higher over time. The 16-channel HDSP-V is composed of 18 boards and the 8-channel HDSP-V of 15.

### **96 KHz (16 ch) and 192 KHz (8 ch) - What is the Sampling Rate?**

The Sampling Rate represents the capacity of the digital signal to reproduce the analog signal more faithfully. The higher it is, the better it is, but the difficulty in processing the signal increases proportionally as well as the power of the processors used. 44 KHz is the sampling rate of a CD disc. The DSPs are normally at 48 KHz. 96 KHz and 192 KHz are the sampling rates of the most sophisticated DSPs. With 192 KHz sampling rate it is possible to have a 192 KHz digital signal line, starting from the Player up to the amplifiers.

### **Very accurate Phase Filter**

The HDSP-V has a very accurate All Pass filter for phase adjustment. It is possible to fix the working frequency of the filter as accurate as 1 Hz and the phase shift also as fine as 1 degree.

### **VSEQ Filter**

This is another innovation of the HDSP-V. Zapco has already introduced this function some time ago in the analogue ASP-OE8 and ASP-OE2 processors. This allows to restore the response on the low frequencies of the OEM systems as it is altered by the original manufacturers in order to protect their weak speakers or other weaknesses when the volume of the radio is increased above a certain level.

## Upgradable internal modules/components

*Zapco thinks to provide a perfect line of signal path to the speakers and through the listening area. For that reason, hardware and software will be easily up-gradable with different modules that can be changed later as the situation requires. In building the HDSP-V digital processors, we used the very best components we could find for a production product. But knowing that there would be high-end users out there with their personal favorite ADCs or DACs, we programmed the HDSP chips to accept different components to provide the more fanatic audiophiles the ability to easily customize the units to their personal tastes.*

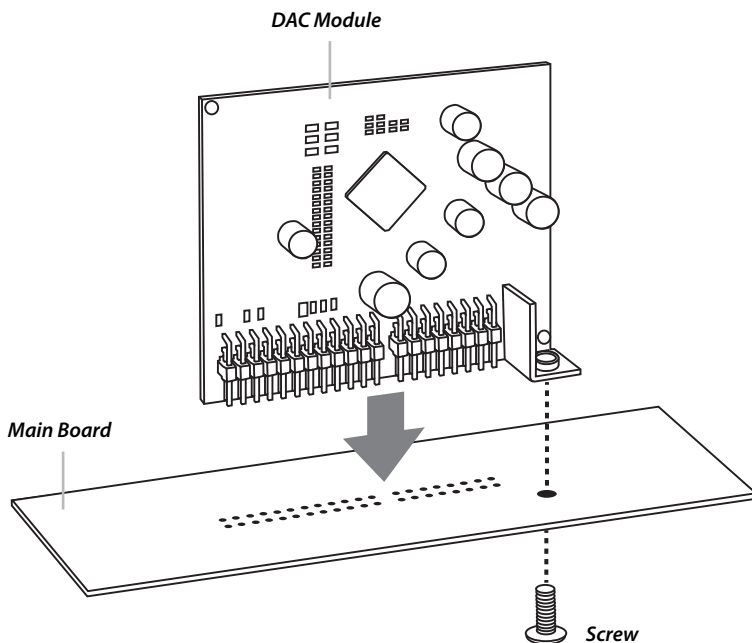

*Changing a DAC board is a straightforward swap. One screw holds each module in its socket. You simply remove all power to the HDSP, remove the top cover and top plate, remove the screw, and gently lift the board out starting with the side that was screwed down. Installation is just the opposite.*

*Note: This is a delicate piece of electronics and parts must be lined up correctly. If you have any concerns at all, please see your Zapco dealer for assistance.*

# HDSP-V AD-A Input End

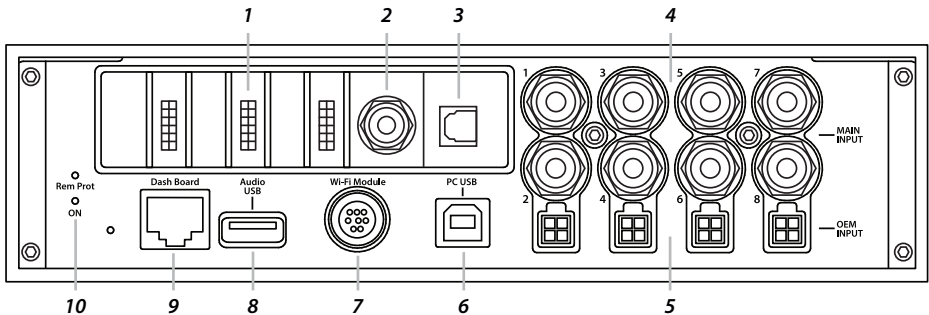

1. Three **i2S (Z.COM)** allow for digital input expansion such as HD Digital Bluetooth Module (optional).

2. **Coaxial Digital Input.**

3. **Toslink Digital Input.**

4. There are up to 8 Channels of input, **Differentially Balanced RCA**s, or High Level speaker inputs, for main input. For maximum sound quality the HDSP units have analog level controls for the inputs tied to LED clip lights. This allows you to get the maximum unclipped (clean) signal for the HDSP to work with. Of the 8 RCA input channels two (In7 and In8) can be used for an Auxiliary RCA input if not all eight inputs are needed for the main in.

5. Below each RCA input pair, there is a pair of **Speaker Level Inputs**, if you are adding the HDSP to an OEM factory stereo you will use these connectors to take the input from the factory stereo system's speaker leads. The wires of each of the four plugs are labeled for correct hookup.

While your head unit may have up to 8 channels of output, we highly recommend that you use only a single full range pair of inputs to the HDSP since the HDSP processing will be far superior to your head unit processing. Also using two different processing stations will greatly complicate the tuning process and add distortion.

The OEM input plugs allow up to 8 channels of speaker level input, but you need only connect enough speaker wires to get a full range signal for the HDSP to work with. Once you have wired the OEM plug the HDSP can sum all the signals together into a full range R/L signal pair as input for all the output channels.

As noted above Input Channels 7 and 8 can be used as additional Low Level audio source. You can switch from Main input to Auxiliary input using the GUI on the PC or by choosing the LINE on the dash remote.

6. **PC USB:** This USB-B receptacle can be used to connect the HDSP processor to a PC for system setup.

7. **WiFi Module:** This DIN receptacle will accept the Zapco Wireless Dongle for wireless connection to a PC for system adjustments.

8. **Audio USB:** The USB-A receptacle accepts FAT 32 formatted USB sticks (up to 2 TB) for up to 24 Bit/192 KHz, HD Music files for the on-board Hi Definition Audio Player.

9. **Dash Board:** The RG Connector accepts the connection to the Wired Remote.

10. **LED Indicators** for power and protection.



# HDSP-V AD-A Output End and Dash Board

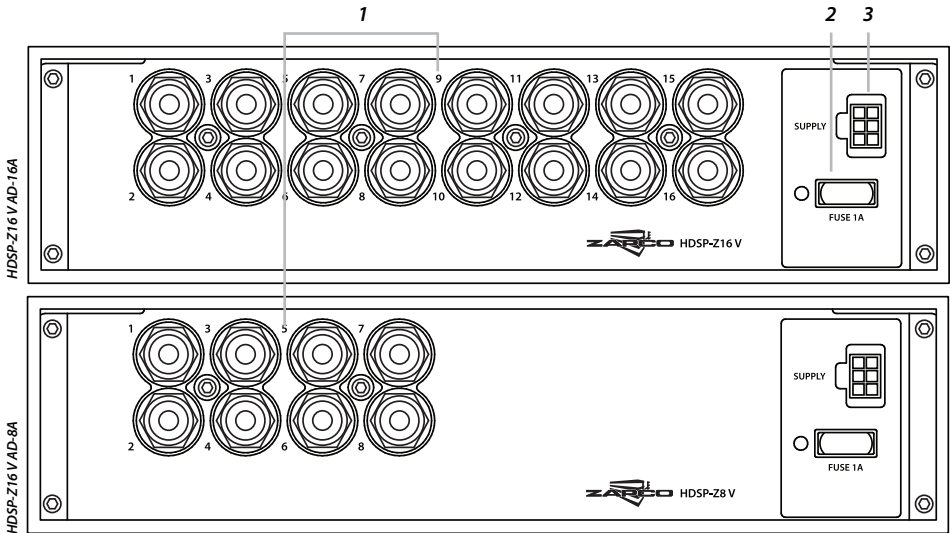

1. The Output end is very straight forward with eight (HDSP-Z16V AD-16A) or four (HDSP-Z16V AD-8A) pairs of Zapco's proprietary **Gold RCA Output** connectors.
2. The **1A Power Fuse**.
3. The processor's **Electrical Connections**. Below is the wire harness with the wire colors.

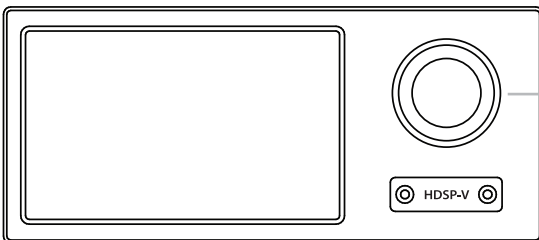

**Power On/Off and Volume Knob**  
 Long press to turn ON or turn OFF the HDSP. A quick push puts the system in MUTE. Tap again to Un-Mute.

# HDSP-V AD-A Cover Plate

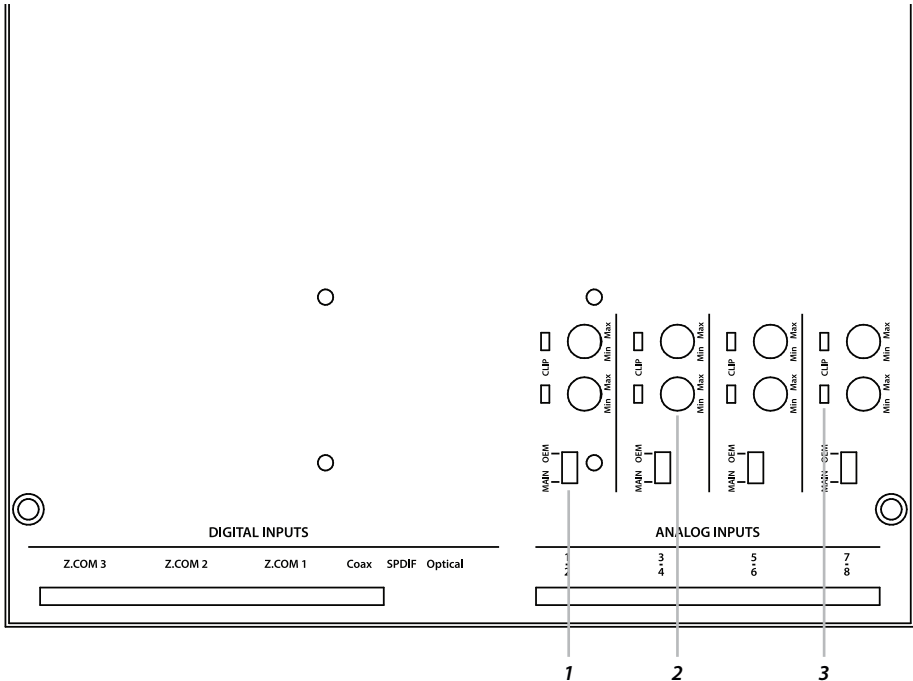

There is a cover plate in the top of the HDSP processors held in place by screws. Under that plate are the main input controls.

1. Each channel pair has a switch to choose **Main (RCA Level)** or **OEM (Speaker Level)** for the main analog inputs.
2. Above the level switches are the **Input Gain Controls**. Each channel has its own gain control.
3. **Clipping Indicator** to adjust gain for the maximum clean (unclipped) signal.

Digital is fast, digital is convenient, but Digital is also limited. Adding gain to a signal after it is already in the digital domain is convenient, but it will use valuable memory resources and it will increase the noise of the system and reduce the signal's dynamic range. The HDSP processors were designed to be the best sounding digital processors... period. To that end we used custom designed high precision analog pots to adjust the input signal to the HDSP. Also, on the HDSP top plate are screens to assist in connecting the outputs and inputs.

# Installing the Control Program (GUI)

The HDSP-V Zapco processors are controlled by a PC using the Zapco Digital Control Program. The program is available for download on the Zapco website: [zapco.com/hdsp-5-support](http://zapco.com/hdsp-5-support) Inside the HDSP-V support page you will find user's manual, software and firmware download and update options. Click **DCP Software v.2.9.2 (Windows PC)** under Control Program. The version number will be the most current version. The program is designed to work on all Windows systems from XP to W-10. After downloading the program, you will find this file in your Downloads folder. Open the .exe file and the installation will begin.



The first screen gives permission to install the program. You will want to click Yes. To avoid any installation issues you should close any other programs you have running and then click Next. By default the program files will be stored in the HDSP-V folder. Here you can assign a different folder though we recommend that you let it use the default folder and click Next.

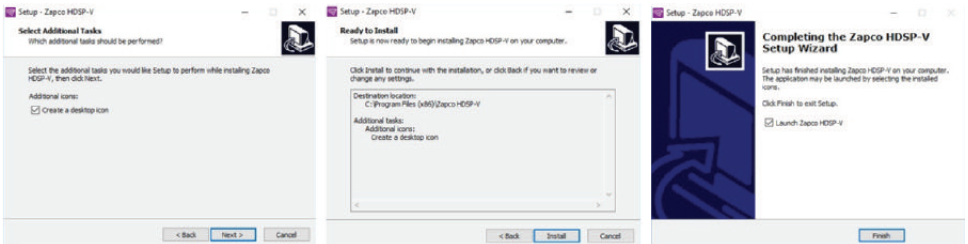

In the next screen you can determine if you will have a desktop icon to open the program. By default the HDSP icon will be installed on the desktop. Click Next. This is the final screen to make the installation. Click Install to proceed. After the installation you can click Finish to close the installation.

## Windows Drivers

The HDSP control program works with Windows system from XP through W-10. In the new 2.9.1 GUI version, we added the signed certification to the driver. This is an autogenerated certification that should be accepted by all the Windows OS from XP to 8.1. This should resolve all the compatibility problems with Windows 7/8/8.1. Note also that is still possible that some version of Windows 7 still show the warning during the installation of the driver due to Windows bug, but it is just a warning, and it will work anyway. If your operative system, for whatever reason, does not recognize the processor, then, you will need to turn off the Driver Signature Verification. Here is a method to do that: Open Advanced Boot Options. Hold down the Shift key and click Restart to get Advanced Options.

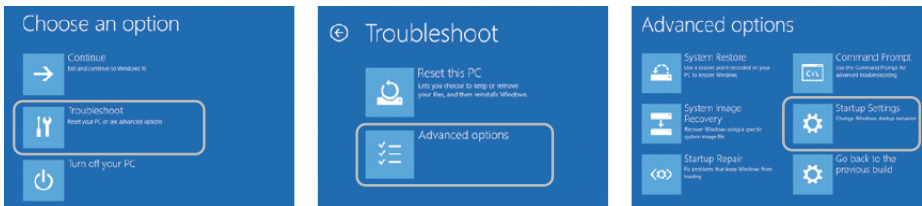

Choose Troubleshoot then choose Advanced Options, and Click Startup Settings.

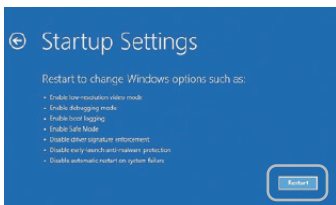

Click Restart to enter startup screen. Press 7 or F7 to disable driver signature enforcement. Then press Enter and you will restart without driver signature enforcement. If you want to turn enforcement back on after you load the drivers, you can do that the same way.

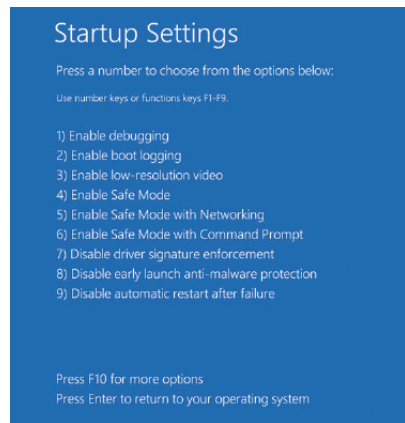

# Unit Installation

The first step in the installation of your processor is to disconnect the negative terminal of the battery to prevent damage to the equipment and to the car's electrical system. The HDSP-V processor needs to be securely mounted in a location where it will not be exposed to excessive heat, moisture, or vibration. When choosing a location be sure there is room for all the cables and wiring that will be connected to HDSP-V and be sure you have easy access to the USB control input to connect to the PC. If you are using the factory high level inputs from an OEM amplifier you will need to bring those connections to the location as well. You will also want to run the cable for your dash remote, leaving plenty of extra cable at the front until you pick a permanent location for the dash remote.

## 12 Volt Connections

- The **+12V Battery** wire should have a 2A fuse mounted in-line within 18 inches of the battery. If you are connecting to a distribution block there should be a 2A fuse in-line at that connection.
  - The **+12V Key (Acc)** power wire allows the HDSP to be turned when the Key is in Acc or Run positions.
  - The **Ground** connection is critical to the performance of the processor. Inadequate or loose ground connections can not only damage the processor, but they open a path for many sources of unwanted noise. Make sure you have a good solid ground point to bare metal which is connected to the car frame.
  - The **+12-Volt In for Turn-On** connects to the turn-on wire from the head unit. All aftermarket units and many factory OEM units have these turn-on trigger wires. When available you should always use them.
  - **Auto-on Sensing:** Many of the newer cars however do not have turn-on wires in the factory harness. For these systems there is an auto-on from Audio Input switch in the GUI that activates sensors that read signal from the speaker input wires and turn on the HDSP automatically when the factory system is turned on.
  - The **+12-Volt Output** connection is used to provide turn-on current for your amplifiers. This connection will be active whether you use the +12 turn-on from the head unit, or you use the Auto-on system. All amplifiers should use this source for the turn-on so the Processor can control the turn-on of the amplifiers.
- NOTE:** To avoid turn-on pops and other noises all amplifiers must use the turn-on output of the HDSP for their trigger inputs. For multiple amplifiers turn on, it is safest to use a relay as below (common Bosch Style Automotive Relay).

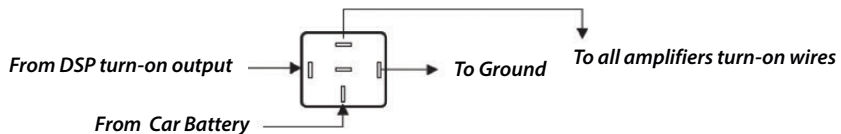

After the +12 Volt and Ground connections are completed you can finalize all the other connections at the HDSP except the RCA signal cables to the amplifiers. These should not be connected to the HDSP until after the input levels and default crossovers are set. This will avoid damage to the speakers during gain setting.

At this point you should have:

- Secure power and ground connections to all system components with fuses at each component and a fuse or fuses at the main feed close to the battery.
- The main input at either the RCA or Spk level input connected, and the input switches are set accordingly.
- Any Auxiliary input cables (RCA or Digital) are run and connected.
- The dash remote cable is run and connected.
- All amplifiers cables and turn-on wires are run and connected. All the amplifier gain controls should be set to minimum at this time but the amplifier signal cables should not be plugged into the HDSP. You can now re-connect the negative battery terminal and prepare for system set-up.

### **First: Input Sensitivity for Radio/CD Head Unit**

To get the best possible signal to noise ratio and the widest dynamic range, you want the HDSP to receive the strongest undistorted signal it can accept. To aid in this, Zapco provides a gain pot and Clip LED for each channel accessed under the top cover as seen earlier in the manual. The first step is to ensure that the Input switch is in the correct position for either MAIN (RCA) or OEM (Speaker level). Check that all tone controls are off and balance controls, and fader controls are set "0" or Center. To set the gains you will turn the system on and watch the LEDs in the gain panel on the top of the DSP.

**Remember: the amplifier RCAs are not plugged in yet, so there will be no sound. You're just watching the LEDs**

To properly set the gains you want to play the most dynamic (usually the loudest) piece of music you are likely to listen to and play it at the highest volume your head unit can play cleanly. If you are unsure about what that volume is, you can consider that most modern head units will play cleanly to about 80% of the volume control, so a little over 3/4 volume. With the volume at this level you can begin adjusting the gain pots up starting with Channels 1/2. Slowly turn the gain pots up until the red LED just flashes and then back off just slightly. The red LED tells you the signal is in the distorted area. At the final position you want the level as high as it can be without flashing the red LED. Of course you need to adjust only those channels you are actually using for input. Most systems with aftermarket head units will only use the inputs Ch1/2.

After you have set the input for the active input channels, be sure to turn the head unit volume back to minimum to avoid bad surprises later, and then turn the system off.

### **Connecting the PC**

Now you should connect your Laptop or PC to the HDSP with the supplied USB cable. Then you can open the Digital Control Program and familiarize yourself with the different GUI pages.

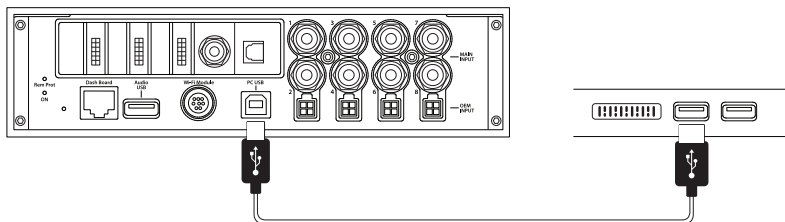

## Opening the Control Program (GUI)

When you click on the Zapco HDSP Heatsink icon you get the splash screen below. Notice the GUI version number (here it is v.2.9.1) on the right side under DIGITAL CONTROL PROGRAM.

The HDSP Series is an evolving product and any number of features will be added as new technologies become available. You will want to keep a regular eye out for updates at [zapco.com/hdsp-5-support](http://zapco.com/hdsp-5-support) to keep your HDSP current.

Before the GUI opens, you need to tell the program if you wish to open in **Connect via WIFI\*** or **Connect via COM\*\*** mode and which HDSP model you will be working with Select Device drop-down menu. If you choose Connect via COM mode you will confirm the COM port number and you can click START to open the GUI.

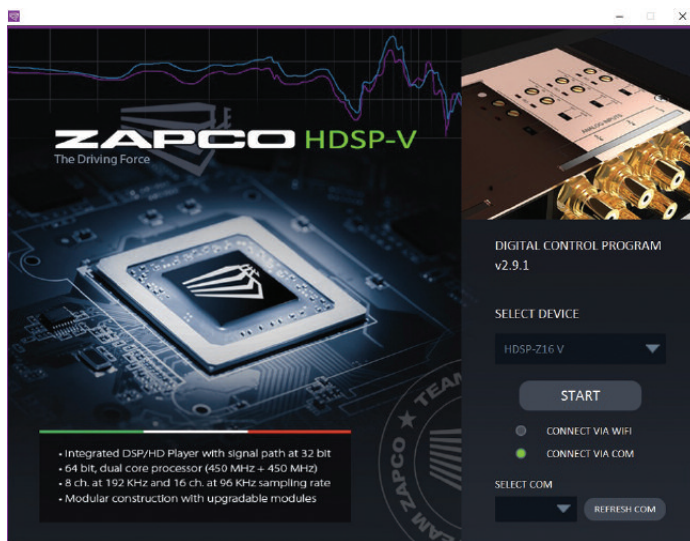

\* Your HDSP processor can be controlled by PC or laptop through either the supplied USB connection or by wireless connection. The initial connection must be by USB, then once the GUI is opened you can enable the WiFi for future connections (see pag. 17 to enable WiFi).

\*\* Different PCs can react differently to USB cables. If the supplied 5m cable does not allow immediate connection (no COM port showed under Select COM, you should try a 2m USB cable).

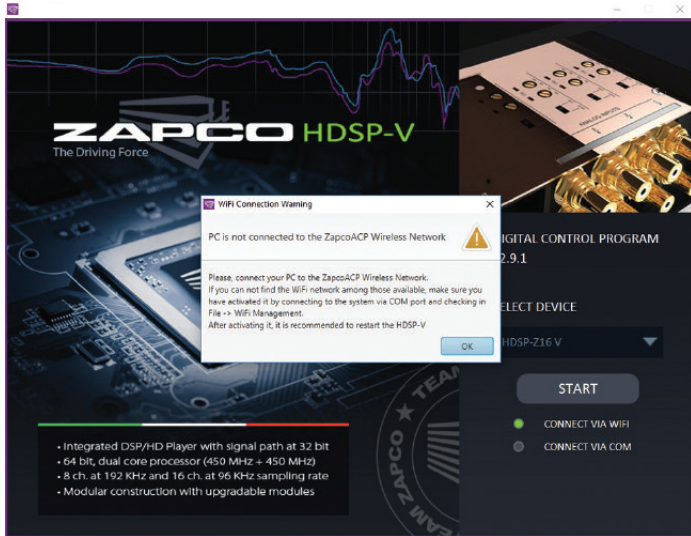

*If you have already used the GUI and you have previously saved some configurations, you can choose which configuration to upload between Last Saved, Default, Choose from PC, or Choose from DSP Preset.*

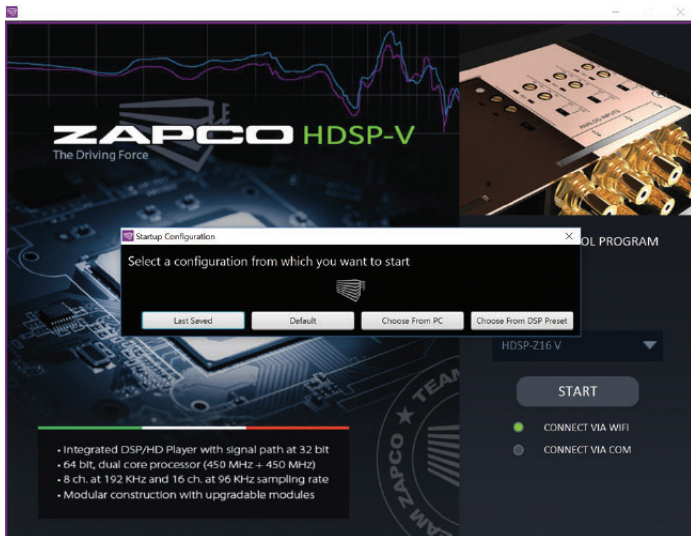



# The HDSP-Z16 V Control Program

The HDSP graphic user interface (GUI) currently consists of a Main page and 5 function pages. The function pages allow a user to set all the channels for a particular function at the same time. The Main page then is an at-a-glance review of the settings and allows fine tuning adjustments that may be needed during the equalization stage.

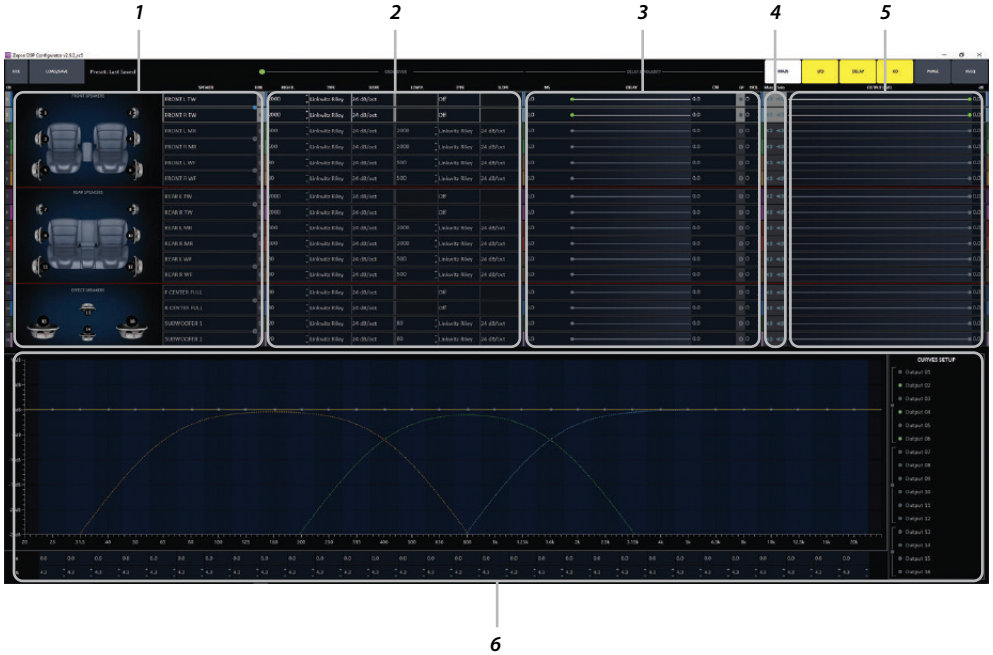

**1. Speaker Channel Assignments:** This section shows the function of each output channel and is where you will choose a channel for fine tuning. The information here is transferred in from the I/O page where the assignments are made.

**2. Crossover Section:** This shows the crossover choices of each output channel. As you assign functions on the I/O page, default crossovers will be assigned to protect speakers. In the Crossover section you can modify the crossovers to match the needs of your particular speakers.

**3. Delay and Polarity:** Signal delay allows you to adjust the arrival time of each channel so that it will sound as though you are dead center in the car, even though you are likely sitting far to one side or the other. All speakers in a system must be “in phase” for tuning to be effective. This means they must be of the same polarity (all moving the same direction at the same time). If a speaker is out of phase with the rest of the system you can change its polarity in the GUI to the right of the delay adjustments.

**4. Mute/Solo:** These buttons allow you to listen to individual speakers or groups of speakers, as needed during fine tuning. If you Right Click on any channel’s mute button you have the option to Mute All or Unmute All.

**5. Output Level:** Here you can adjust for any channels whose output level is not as needed for the correct overall sound.

**6. Equalizer:** This is the section where you will do the fine tuning. We will discuss more about equalizing later in the system setup. The Equalizer is on the Main page, so you can have all your other settings handy for fine adjustments as needed during the equalization procedure.

## The Navigation Bar

At the top of the Main page is the navigation bar. On the right side the navigation bar are the links to the function pages. At the left side you will find the FILE menu and the LOAD/SAVE menu.



**FILE Menu:** The file holds the several functions below.

**WiFi Management:** Your HDSP processor can be controlled by PC or laptop through either the supplied USB connection or by wireless connection. The initial connection must be by USB, then once the GUI is opened you can enable the WiFi for future connections (be sure to connect the WiFi dongle at the round Mini DIN WiFi port on the processors input side).

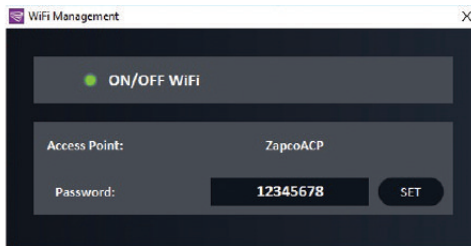
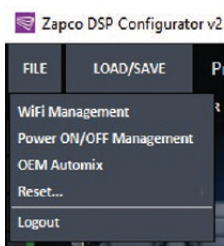

ZapcoACP is your access point. The default password is 12345678. You can change the password by highlighting the current password and clicking SET.

**Power ON/OFF Management** - The On/Off function of electrical components cause pulses that can be amplified by the system's amplifier and cause "POP" noises. The HDSP firmware and software are designed to prevent this. The Power On/Off menu lets you modify the On /Off delays to best suit your system's needs. From the factory, the HDSP will turn on with only power and ground by pushing the Volume knob of the Dashboard remote. One of the first things you should do is what system you will use for On/Off triggers. A couple of notes are needed for Power by Audio in and for the timing of the amplifier turn-on from the HDSP. For the Power On/Off by Audio In you will want a short delay for On, but a long delay for Off. The lower section is to control the amplifier turn-on from the White +12v out. Power off delays are normally not used because you want the amp to turn off fast so it cannot amplify the turn-off pulse. This is often a problem because most processors that have turn-on wires must turn off before the amp trigger can turn off. The HDSP lets you set a delay for the amp turn-on and delay, or no delay, for amp turn-off. The third setting (Off Power Enable Delay) lets you set a delay time that keeps the HDSP on until after the amp has had time to shut off completely so there will be no turn-off noise.



**Reset** - Allows you to undo changes you have made to the system. You can choose to return to the default settings of the desired parameter or you can simply return to the last saved value to undo only the last adjustment.

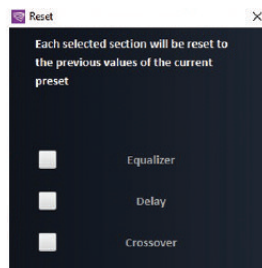
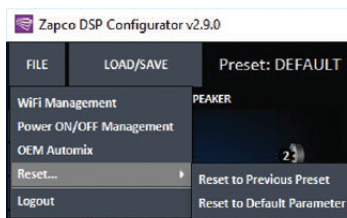

**OEM Automix:** Most new vehicles have information/warning systems operating through the factory stereo system. Since the HDSP has a considerable number of input choices beyond the factory stereo we have included the OEM Auto-Mix function so your information system will work regardless of your music source. Given that there are many differences in signal level in different vehicles, the OEM Auto-mix function lets you determine the threshold of the signal to be allowed to mix into the music and the volume of the information signal in relation to the music signal.

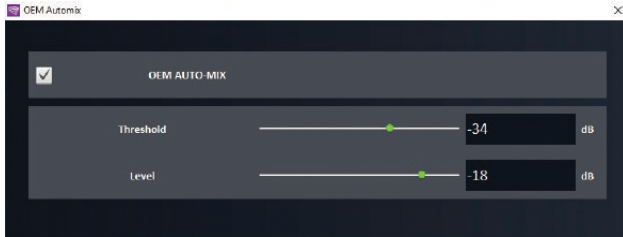

**Logout:** Logout will save close the GUI screen and return you to the opening splash screen.

**LOAD/SAVE Menu:** You can load or save to a file on your computer or to one of the 10 presets in the HDSP-V. **To PC File** - The HDSP program installed a folder on your PC specifically for storing and retrieving preset configurations. When you choose Save to PC file you will be taken to the Preset 16Ch or Preset 8Ch folder. The System will apply a name for the configuration which will be highlighted when the folder opens. You can choose to keep that name, but it is recommended that you assign your own name. ie Rock Tune, Competition Tune, etc. The name of the current preset will always show in the navigation bar next to the LOAD/SAVE icon. **To Device** - Saving to Device puts the preset configuration into one of the HDSP's on-board memory positions. As with the PC file, you will assign a preset number and be asked to assign a name to the preset.

### Navigation Bar (or Traffic) Lights

At the right side of the Navigation bar you will see the function buttons that can be lit green, yellow, or red. You can change the color of these lights as needed. These green, red, and yellow lights have been added to be used as reminders to help assure that your system setup is complete. Just like traffic lights, green indicates that a process is completed, and you can continue on, yellow means you may need to check on the function before moving on, and red means something definitely needs to be done before proceeding.



When you first open the GUI of your HDSP processor you will find that three of the function buttons are yellow. These are the I/O page, then Delay page, and the Crossover (XO) page. They are yellow because by default the HDSP opens to a default system and you will need to check these items as they may (and likely will) need modification to fit the needs of your particular system.



As you open each page and set all the function to match your system needs you can turn the yellow lights to green by double clicking the lighted icon.



If you find something definitely wrong and want to be sure you change it before you are finished, you can change that icon to red as a reminder to change it before exiting the program.



If you have finished all the set-up functions, you can turn all lights to green and proceed with equalization and other tuning functions.

## Setting Up the Sound System with the PC GUI

The GUI for the HDSP processors will lead you through a complete system setup in the shortest possible time by simply putting everything in a logical order of flow. It also follows the Zapco philosophy that the simplest is best. We don't waste processing power on things that aren't necessary for tuning. We put it in an advanced phase control that lets you select the exact frequency of a needed phase shift and precisely what the phase shift should be. We put it in a VSEQ that allows you to seamlessly correct for volume dependent equalization car makers are using to hide the flaws in factory systems. So the HDSP GUI provides tool for the most advanced tuning while at the same time, letting the first-timer set a system up with ease.

Below we will go through a full system setup starting right at the beginning, by defining the system in terms of speakers and functions.

# The I/O Page

The first page you need to set up is the I/O (Input/Output) page. Here you define your output channels (Speakers), your input channels and your active input sources.

Before starting you need to know what inputs you are using, what speakers you are using, and how many output channels you will have.

The screenshot shows the 'I/O Window' software interface. At the top, there are tabs for 'MAIN', 'I/O', 'DELAY', 'XD', 'PHASE', and 'USEQ'. The 'I/O' tab is selected. The interface is divided into several sections:

- INPUT MODE:** A vertical list of options: Main, COAX, TOSLINK, Z-COM 1, Z-COM 2, Z-COM 3, HD, and LIVE SOURCE. 'Main' is selected.
- SPEAKER DIAGRAM:** A visual representation of a 16-channel speaker system with numbered speakers (1-16) and a subwoofer icon.
- OUTPUT:** A table of 16 channels with columns for 'CH', 'L-IN 1' through 'L-IN 8', 'LEFT', 'RIGHT', 'L-1', and 'L-2'. Each channel has a 'Speaker Function' dropdown and a volume percentage slider.

CH	IN/OUT CHANNEL CONFIGURATION								LEFT	RIGHT	L-1	L-2
	AVAIL...	AVAIL...	AVAIL...	AVAIL...	AVAIL...	AVAIL...	NOT U...	NOT U...				
1	83%		53%		53%				100%			
2		83%			83%		83%			100%		
3	83%		83%		83%				100%			
4		83%			83%		83%			100%		
5	83%		83%		83%				100%			
6		83%			83%		83%			100%		
7	83%		83%		83%				100%			
8		83%			83%		83%			100%		
9	83%		83%		83%				100%			
10		83%			83%		83%			100%		
11	83%		83%		83%				100%			
12		83%			83%		83%			100%		
13	16%	16%	16%	16%	16%	16%	16%		100%			
14	16%	16%	16%	16%	16%	16%	16%		100%			
15	16%	16%	16%	16%	16%	16%	16%		100%			
16	16%	16%	16%	16%	16%	16%	16%		100%			

## Defining Outputs

When you first open the page, you will find the default system above. This is the most complicated of systems. It uses all 16 channels and OEM Summing to adapt a high end factory stereo into the HDSP and also has the HD Player as an input by default. Most certainly you will now need to modify the I/O page to suit your particular system. At the left side you see INPUT MODE, then a SPEAKER DIAGRAM for the default 16-ch. system and the OUTPUT channels with the Speaker Functions for all 16 channels.

a) The first thing you will do is use the drop-down menus under Speaker Function to assign the proper function to each channel (speaker) in your system. Any channels you will not be using, you will label NOT USED. b) Once this is done you choose the Inputs you are configuring from INPUT MODE. If you are using an aftermarket head unit you should use only the 2-CH (as explained earlier) Main input. If you are using high level OEM input you choose 2 CH, 4 CH, 6 CH or 8 CH, as needed to get a full range signal then use OEM Sum.

c) Once that is done, you click SET and the system will adjust the speaker diagram, install default crossovers, and open (or clear) the I/O matrix so you can assign the needed inputs to each output channel.

## Defining Inputs

To the right of the OUTPUT section is the I/O Matrix. When you choose your input and click SET, the input squares in the matrix open and they say ON at the top. If you wish, you can click any ON square and get a drop-down menu where you can name the input by function (i.e. FL Full, or Center, or Subwoofer, etc.). While this is functionally an 8-Channel processor, the actual mechanics of the HDSP processors has 12 input channels. 8 input channels are available for an aftermarket or OEM head unit. 2 channels (LEFT and RIGHT) are there to accept fixed 2-channel digital sources and the auxiliary LINE input (if only 6 inputs are used in the OEM section). 2 more inputs (L-1 and L-2) are available in the Loop section for creating special effects, which we will discuss later in the Special Features section. Below is a 12-channel system with a 2-channel input. When we clicked SET inputs L-IN 1 and L-IN 2 opened and turned ON. We assigned input 1 to all left speakers and input 2 to all right speakers. The subwoofers are mono, so we assigned both left and right inputs to them. When you assign multiple inputs to a channel, they are distributed evenly to total 100%.

**Advanced Tuning:** You can change the percentages if you wish for special effects by clicking the up/down arrows in the matrix boxes and using your up/down keyboard arrows. Right clicking in a box will also allow you to change the polarity of the box. You can use any combination of adding or subtracting inputs for any speaker channel, BUT, this should only be done by experienced tuners who know exactly the effect they are looking for.

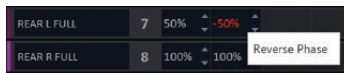

INPUT MODE	SPEAKER DIAGRAM	OUTPUT	CH	L-IN 1	L-IN 2	L-IN 3	L-IN 4	L-IN 5	L-IN 6	L-IN 7	L-IN 8	LEFT	RIGHT	L-1	L-2
Main	CONFIGURE SET	Speaker Function		ON	ON									NOT USED	NOT USED
2 CH		FRONT L TW	1	100%											
4 CH	1 2	FRONT R TW	2		100%										
6 CH		FRONT L MR	3	100%											
8 CH		FRONT R MR	4		100%										
OEM SUM		FRONT L WF	5	100%											
		FRONT R WF	6		100%										
LINE		REAR L FULL	7	100%											
COAX		REAR R FULL	8		100%										
TOSLINK		SUBWOOFER 1	9	50%	50%										
I250		SUBWOOFER 1	10	50%	50%										
I251		SUBWOOFER 2	11	50%	50%										
I252		SUBWOOFER 2	12	50%	50%										
HD	EFFECT SPEAKERS	NOT USED	13												
		NOT USED	14												
LIVE SOURCE		NOT USED	15												
		NOT USED	16												



After you have defined your system with the Main input you will want to set up the HD Player, any digital inputs you are using and the LINE input, if that is available, by choosing the desired source and then choosing SET.

Below is the same system you see above, with all the inputs configured. At the bottom of the INPUT MODE section you see LIVE SOURCE. When you first open the GUI this says only OEM. Each time you add another input source to your setup it will be added to the LIVE SOURCE drop-down menu. This is where you will pick the source you are tuning with the PC. Each source that has been added to the configuration will show in Green under INPUT MODE, as well as in the ACTIVE SOURCE drop-down.

You can also start by clicking all the sources you will use and click SET to open all the needed columns at the same time and then configure the inputs on both the 8 input side and the 2 input side.

INPUT MODE	SPEAKER DIAGRAM	OUTPUT	CH	IN/OUT CHANNEL CONFIGURATION								LEFT	RIGHT	L-1	L-2
				L-IN 1	L-IN 2	L-IN 3	L-IN 4	L-IN 5	L-IN 6	L-IN 7	L-IN 8				
Main	CONFIGURE SET	Speaker Function		ON	ON	OFF	OFF	OFF	OFF	OFF	ON			NOT USED	NOT USED
2 CH		FRONT L TW	1	100%							100%				
4 CH		FRONT R TW	2		100%							100%			
6 CH		FRONT L MR	3	100%							100%				
8 CH		FRONT R MR	4		100%							100%			
OEM SUM		FRONT L WF	5	100%							100%				
LINE		FRONT R WF	6		100%							100%			
COAX		REAR L FULL	7	100%							100%				
TOSLINK		REAR R FULL	8		100%							100%			
I250		SUBWOOFER 1	9	50%	50%						50%	50%			
I251		SUBWOOFER 1	10	50%	50%						50%	50%			
I252		SUBWOOFER 2	11	50%	50%						50%	50%			
HD	EFFECT SPEAKERS	NOT USED	12	50%	50%						50%	50%			
LIVE SOURCE		NOT USED	13												
OEM		NOT USED	14												
		NOT USED	15												
		NOT USED	16												



## Auto-Summing

OEM SUM: If you are using OEM inputs and need to sum channels you can do that manually by clicking in each of the appropriate boxes in the matrix. However, the GUI will also do that for you automatically with the touch of a button. Below is the same speaker arrangement as above but using 6 channels of input (3 stereo pairs). Tell the GUI you have 6 input channels and click OEM SUM and the channels are properly distributed in the matrix.

In the system below the GUI has auto-summed 6 channels of High Level input.

Immediately under the ON/Name box of each input column in the 1~8 OEM section there are up down arrows to make fine adjustments of the input levels. There are no adjustments on the (9~10) Stereo channels as these are fixed inputs.

The screenshot displays the 'I/O Window' interface with the 'OEM SUM' option selected. The 'IN/OUT CHANNEL CONFIGURATION' table is as follows:

INPUT MODE	SPEAKER DIAGRAM	OUTPUT	CH	IN/OUT CHANNEL CONFIGURATION								LEFT	RIGHT	L-1	L-2
				L-IN 1	L-IN 2	L-IN 3	L-IN 4	L-IN 5	L-IN 6	L-IN 7	L-IN 8				
Main		Speaker Function		ON	ON	ON	ON	ON	ON	ON	ON	ON	NOT USED	NOT USED	
2 CH		FRONT L TW	1	33%		33%		33%				100%			
4 CH		FRONT R TW	2		33%		33%		33%			100%			
6 CH		FRONT L MR	3	33%		33%		33%				100%			
8 CH		FRONT R MR	4		33%		33%		33%			100%			
OEM SUM		FRONT L WF	5	33%		33%		33%				100%			
		FRONT R WF	6		33%		33%		33%			100%			
LINE		REAR L FULL	7	33%		33%		33%				100%			
COAX		REAR R FULL	8		33%		33%		33%			100%			
TOSLINK		SUBWOOFER 1	9	16%	16%	16%	16%	16%	16%	16%		50%	50%		
I250		SUBWOOFER 1	10	16%	16%	16%	16%	16%	16%	16%		50%	50%		
I251		SUBWOOFER 2	11	16%	16%	16%	16%	16%	16%	16%		50%	50%		
I252		SUBWOOFER 2	12	16%	16%	16%	16%	16%	16%	16%		50%	50%		
HD	EFFECT SPEAKERS	NOT USED	13												
LIVE SOURCE		NOT USED	14												
		NOT USED	15												
		NOT USED	16												

# The Delay Page

The ideal position for listening to a stereo system is dead center between the two speakers forming an equilateral triangle. That way the sounds from each speaker will arrive to you at the proper time to give you a good and accurate impression of the width and depth of the sound stage and each instrument's place in it. In a car it is virtually impossible to be in the center of the listening area. Some speakers may be in the dash and some in the door, and the woofers in the back. Your position? Your sitting completely at one side of the car.

Signal delay corrects for these positioning problems by delaying the arrival time of the near sounds, so they arrive at the same time as the far sounds. The result is that it sounds like you are dead center as all the speakers sound to be the same distance from you.

The screenshot shows the 'Delay Window' software interface. It features a top navigation bar with tabs for 'MAIN', 'EQ', 'DELAY', 'X3', 'PHASE', and 'VSEQ'. The 'DELAY' tab is active. The interface is divided into sections for 'CAR'S SPEAKER', 'EFFECT SPEAKERS', and 'DELAY & POLARITY'. The 'DELAY & POLARITY' section contains a table of speaker settings. The 'REAR L FULL' and 'REAR R FULL' rows are highlighted with red boxes, indicating the current selection. The 'EFFECT SPEAKERS' section shows 'NOT USED' for all entries.

CH	CAR'S SPEAKER	SPEAKER	SCALE		MS		DELAY & POLARITY		DELAY GROUPS		
			0-10ms	1.55	0-10ms	MS	DELAY	INCH	POLARITY	GP1	GP2
1	1	FRONT L TW	0-10ms	1.55	0-10ms	26.38	0	0	●	○	○
2	2	FRONT R TW	0-10ms	1.54	0-10ms	47.85	0	0	●	○	○
3	3	FRONT L MR	0-10ms	1.92	0-10ms	25.97	0	0	●	○	○
4	4	FRONT R MR	0-10ms	3.39	0-10ms	45.85	0	0	●	○	○
5	5	FRONT L WF	0-10ms	2.14	0-10ms	28.95	0	0	●	○	○
6	6	FRONT R WF	0-10ms	3.72	0-10ms	50.32	0	0	●	○	○
7	7	REAR L FULL	0-100ms	60.26	0-100ms	815.1	0	0	○	●	○
8		REAR R FULL	0-100ms	60.26	0-100ms	815.1	0	0	○	●	○
9	7	SUBWOOFER 1	0-10ms	8.0	0-10ms	108.21	0	0	○	○	●
10		SUBWOOFER 1	0-10ms	8.0	0-10ms	108.21	0	0	○	○	●
11		SUBWOOFER 2	0-10ms	8.0	0-10ms	108.21	0	0	○	○	●
17		SUBWOOFER 2	0-10ms	8.0	0-10ms	108.21	0	0	○	○	●
13	EFFECT SPEAKERS	NOT USED	0-10ms	0.0	0-10ms	0.0	0	0	○	○	○
14		NOT USED	0-10ms	0.0	0-10ms	0.0	0	0	○	○	○
15		NOT USED	0-10ms	0.0	0-10ms	0.0	0	0	○	○	○
16		NOT USED	0-10ms	0.0	0-10ms	0.0	0	0	○	○	○

The delay page lets you adjust delay by **Time** or **Distance**. Distance can be measured in either CM or INCH units. Simply clicking the measurement unit at the top of the column changes it to the other unit.

To set the delay and make it appear that all speakers are the same distance from you:

- Measure the distance between each speaker and where your ears will be in the actual listening position.
  - Identify the farthest speaker.
  - Add distance to each of the other speaker so that ALL speakers have the same distance. You do this by subtracting each of the shorter speaker distances from the longest. (See Example Below).
- Here we show delay for an 8-channel system, but the method is the same for any number of channels.

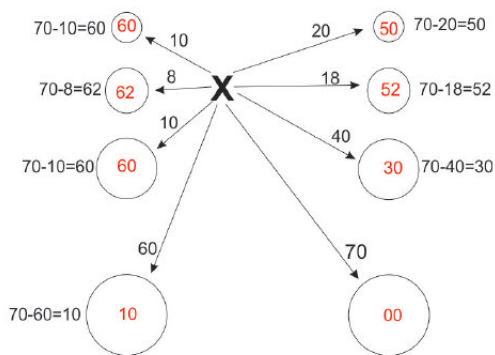

SCALE	MS	DELAY	INCH
0-10ms	4.44		60.06
0-10ms	3.7		50.05
0-10ms	4.58		61.95
0-10ms	3.84		51.94
0-10ms	4.44		60.06
0-10ms	2.22		30.03
0-10ms	0.74		10.00
0-10ms	0.0		0.0

In this example, the longest speaker distance is 70" so we subtract each of the other speakers from 70 and enter the results in the Delay Page. As you put in each speaker in centimeters or inches and hit Enter, the program will change the number to round to the nearest .01 ms.

The delay page also allows you to set up three **Delay Groups**, so you are able to move the apparent position of a group of speakers in relation to the rest of the system. i.e. you may want to move the rear fill farther back from the front stage to make the room sound larger.

After the delays are set, the information will be transferred to the Main page so there is a reminder of both delay and group positions while fine tuning the system.

Delay and phase are intimately related. Changing the polarity of a pair of speakers changes the apparent distance, especially in the bass regions where the wave lengths are long. It also changes the phase relationship between different speaker pairs at the crossover point. The delay page has buttons to change the polarity of each channel if needed. On page 34 of this manual you will find a procedure for setting polarity of the speakers.

You should perform the system phasing (Polarity Check) after the crossovers are set and before any equalization is attempted because if polarities are not correct there will be issues that can not be overcome through tuning.

# The Crossover Page



Above, you see the crossover page of a 12-channel system with channels 1/2 highlighted. When you fill in the I/O page, default crossovers are set for each speaker. On the crossover page you can modify the default values to match the needs of your particular speakers. There are HIGH PASS and LOW-PASS filters available for every output channel. Drop-down menus let you choose the Type (SHAPE) of crossover you wish to use and the SLOPE of the crossover. For the Crossover frequencies you can highlight a box and type in the frequencies, click in the box and use your keyboard Up/Down, or you can click on the up/down arrows in the frequency box.

The best source of information about proper crossover choices is always the speaker manufacturer. They can tell you the best frequency and slope to get the best performance from their products.

**Note:** There are link buttons on various pages of the GUI, to make identical changes to multiple channels. Blue link buttons link pairs of channels only, while Green link buttons link any combination of channels.

## Using the Crossover Page

First note the Blue link buttons for each pair of speakers. All speakers used in pairs should be linked to assure that left and right crossovers are identical. As you set crossover values, the crossovers trace will show in two places. It will show in one of the three **Crossover Curves** sections Ch1~Ch6, Ch7~Ch 12, or Ch13~Ch16. The crossover curves area will show all active crossovers in each section, while the large EQ graph will show the crossover of the channel you are currently working on.

At the right of the EQ graph is the **Curves Setup** column where you can add curves to the graph if you need to see how the curves interact.

The SUM trace: The yellow trace in the graph is the sum line. This trace shows how your crossover choices affect the response of the signal output. Every system will need to be equalized to get the proper frequency response, but improper crossover choices will make the equalization job much more difficult. The Sum trace will add both left and right signal and run above the actual crossover traces. If you show only one channel of each pair, you can keep the sum at the same level as the crossover trace as below.

We have chosen to look at the traces of one tweeter, one midrange, one mid-bass, and one subwoofer. Yellow sum trace is flat so the crossovers are correct. At the left below, you see crossover filters too far apart causing a hole in the response. On the right, the filters are overlapping, causing a peak in the response.

In both of these cases below, the crossover choices are making the tuning of the system more difficult. The yellow sum trace should always be flat when you are finished setting the crossovers

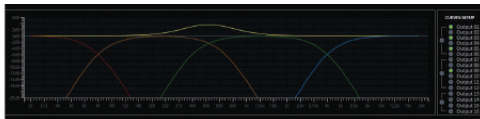
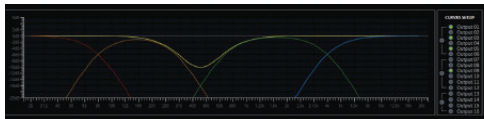
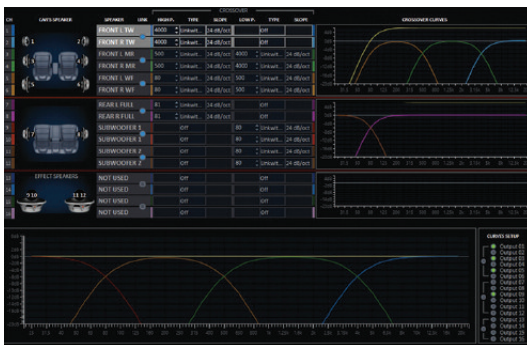

# The Phase Page

*Note: This section concerns the Phase. We included an advanced phase control in the HDSP-V GUI. Phase control can be a magic bullet to solve some tuning issues. However, it can also do far more harm than good to the sound stage, if used incorrectly or used too much. We highly recommend that only experienced tuners use the phase variable phase tool.*

## Understanding Phase

*Sound flows in waves. Pleasant sound flows in smooth waves. When a speaker makes a note it starts at rest, it pushes OUT, then it comes back past rest to IN, then it returns to rest. This movement of pushing and pulling air creates the sound wave. A smooth pleasant wave shape is the sine wave.*

*Here is the wave expressed in degrees. When music is played, each and every note is on its particular spot on its wave form. If the recorded music does not maintain each noted place the sound of the whole is changed.*

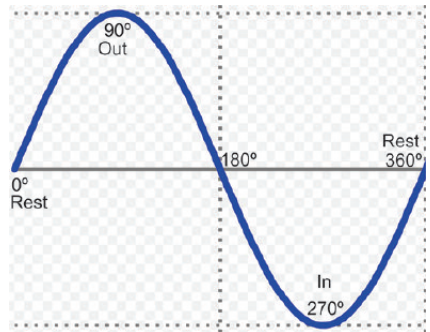

*Two notes of the same frequency and size that are in phase make twice the volume of one, as in diagram A. However, those same notes at 180° out of phase cancel each other out and there is no sound, as in the red line of diagram B. Diagram B is also what happens when two speakers are wired with different polarity.*

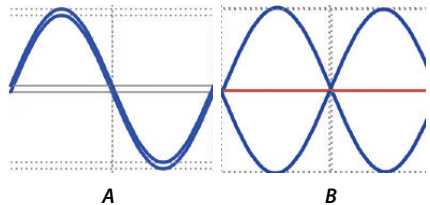

*The variable phase tool: The phase page is a tool that allows you to modify the phase of each channel. You can control the amount of phase shift in degrees, and you can determine the frequency where that phase shift occurs.*





When you open the phase page you will see that the frequency choice has already been made by default at the high pass crossover frequency of all channels except the subwoofer channels, which needs only low pass filters. This is because almost all times a phase shift is used it is to correct a frequency null (no sound) caused by the inherent phase shift made by the crossover filters. In the example above the HP filter of the woofer has been changed to better blend with the Subs.

You can adjust both Frequency and Shift roughly by dragging the slider buttons to the desired location. You can also adjust either using the right and left arrow keys on your keyboard. This can adjust quickly or adjust by single frequencies (or single degrees).

Always keep in mind that a Phase shift affects all frequencies of a channel. When you change the phase at one frequency you change the phase of all frequencies in that channel. But, since they are different wave lengths they will be adjusted by a different amounts. If you are making Phase adjustments, you must keep an ear to all frequencies as it is possible to fix one frequency but create a new problem at another frequency. Be listening while you make changes and make only enough to fix the problem.

# The VSEQ Page



Over the past few years more and more auto makers have been using digital processors to modify frequency response as volume changes. The VSEQ is used to overcome this with an active EQ band in each channel that can be turned on and off by the volume of the OEM radio.

The most common issue is that the car maker reduces the amount of bass as volume increases. The VSEQ allows you to set a low threshold and a high threshold. When the volume reaches the low threshold the EQ filter becomes active. When you reach the high threshold the filter planes and does not increase any more. Between the two threshold points, there is a gradual boost so the EQ is audibly invisible and does its job unnoticed. Setting the VSEQ can be done by ear but is best done using an RTA. Turn the system on to a low volume and watch the Frequency response. When you hear and see the base start to roll off compared to the mids and highs you click SET to activate the low threshold. Continue to increase the volume. Shortly you will see the response stabilize. Click the SET button on the high threshold. You can control the amount of gain at the high threshold using the gain slider, and you can control the speed of the boost using the Q slider. Most of the companies rolling off bass frequencies are using a gain and Q that requires a re-equalization shape similar to what we show above.



# The Equalizer

The Zapco HDSP-Z16 V has a unique advanced equalizer. Processors have a hurdle; Low frequencies take a great deal of processing power. The common practice then is to "downsample" the bass frequencies on the assumption that you won't hear it. Since our chip has twice the processing power of other processors, we doubled the processing power of the first 15 bands so you have the same accuracy in the bass areas as you have in the easier upper mid and high ranges.

There are 30 parametric bands on each of the first 12 channels and 6 bands per channel on channels 13 to 16. The gain of each band is adjustable from +6dB to -15dB in steps of 0.1dB, and the Q is adjustable from .5 to 15 in steps of 0.1. The Q determines the shape of the boost or cut with a low Q affecting a wide area and a high Q affecting a narrow range of frequencies as below.

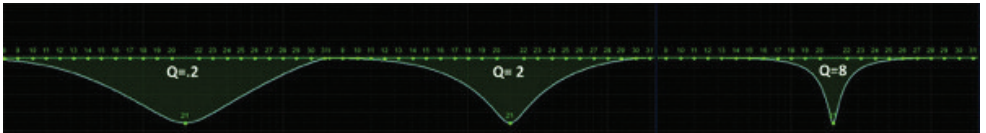

Equalization is done from the Main page. You will see below There are two LINK rows in the upper section of the Main Page. The Green buttons are not for equalization, they are used to make identical volume adjustments to a group of channels. For equalization you use the Blue link buttons to link the left and right speakers of each range as a pair (ie left and right tweeters together). Your first equalization should always be made by linked pairs. For advanced tuning you can unlink the channels and adjust them separately.

If you want to link two channels that have been EQ'd slightly differently you will get the notice above to choose to keep the relative separation or to have one channel copy to the other.

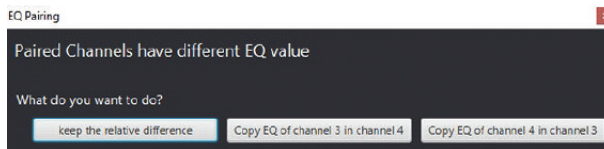

Another tool is the Mute/Solo column. These buttons allow you to mute the speakers you do not want to hear or to listen to only one speaker at a time. As mentioned early in the manual, right clicking any mute button lets you Mute All or Un-Mute All. Also remember the Reset functions under the FILE menu if you want to undo a setting.

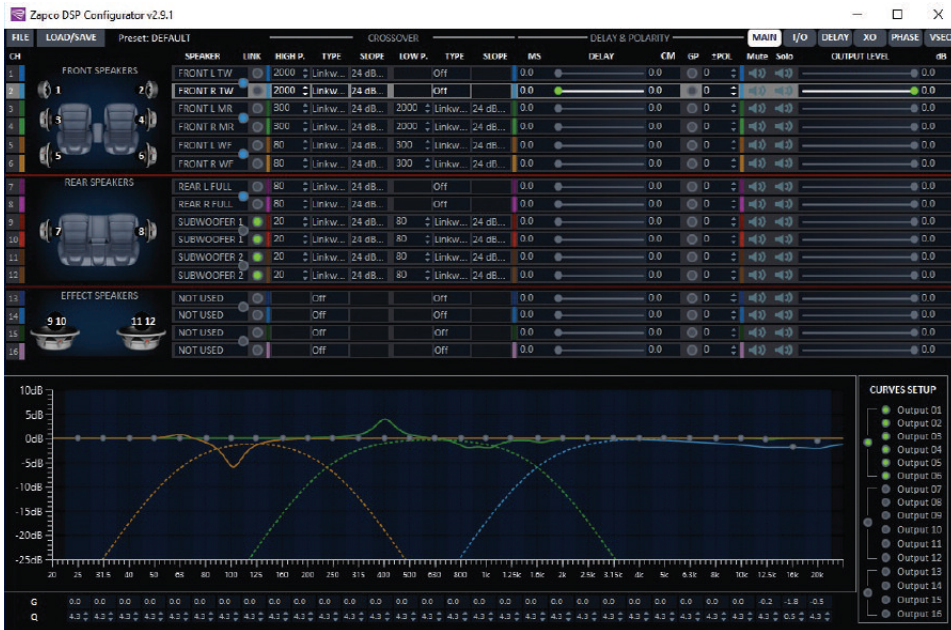

The traces in the EQ graph show what you are doing to the signal. The EQ traces of the active channels (in this case, channels 3/4) are always shown in the graph however you can add other channels you want to see at the same time with the buttons at the right. You can turn them on one at a time or by groups. Here we have the traces of 3 pairs of channels visible. Always remember: Equalization should be done with an RTA. The graph shows what you are doing to the signal, but the RTA shows what the resulting response in the car is. You don't want to confuse the two.

When you click on one of the EQ band buttons you will see what band you are using (1 to 30), the frequency you are at, and the Gain (+ or -) that you are applying. The Q and Gain blocks for that button will be Highlighted below.

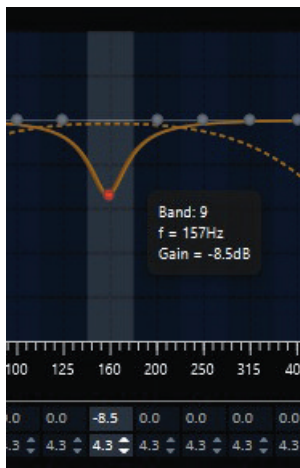

**Choosing a frequency button.** Click on a band (frequency) button and the button will highlight for adjustment. You can change band buttons by clicking on another button, but you can also move sideways through the bands by keystroke, using the Tab key to move up the bands to the right and Shift-Tab to move down the bands to the left.

**Gain/Cut.** Once you click onto a band button, you can quickly drag it to the position you want it or you can use the keyboard Up/Down arrows to move it.

**Frequency.** Works much the same way. You can drag the dot to where you want it, or you can use the right/left keyboard arrows to move up or down the frequency range.

**Q Adjustment.** When you choose a frequency (Band) button the Gain and Q blocks for that band will highlight. You can then use the up/down arrows to change Q. Also, you can change the Q of any band at any time by clicking into a Q block. The block will be highlighted by a blue square. You can then use your up/down keyboard arrows to change the Q for that band. You can also use the left/right arrows to move to across the other bands along the row.

# Speaker Polarity and Phasing

You were promised more on polarity. Before equalization you should assure that all speakers are in phase as a system at the listening position. All speakers need to have the same polarity so they move the same direction at the same time. If they are not, you will not be able to get a proper tune. There are a number of methods for doing this. We offer one.

**Tweeters (A):** Mute all speakers except the tweeters and play a high female vocal soloist. You should hear the voice at a single point near upper middle of the windshield. If the speakers are out of phase the voice will not be localized but will seem to come from everywhere. To test: Using the Phase buttons, change the phase of the right speaker and listen for the difference. Do this a couple of times as needed. The position that puts the voice in a small single location on the window is the correct phase.

**Tweeters (B):** Note where the Tweeter center is located. It should be just slightly above and to the left of the center of the windshield (for left hand drive cars). If it is off to the opposite side of center or too far to the left, and if you have measured correctly, then you have a gain difference and you can correct by a slight level adjustment reduce the right tweeter to bring it left or reduce the left channel to take it right. No more than 1dB or 2dB. Now the tweeters are set. From here on out you cannot change the levels or phase of either tweeter.

**Mids, Mid-bass (woofers), and Subs:** Now mute the tweeters and un-mute the midranges. The process is the same for each pair of speakers. The sound should come from a single focused point near the center of the windshield. For midranges and larger drivers, you want to use a deeper male vocal. The larger drivers are much easier to tell the differences between in-phase and out of phase. Also, with the larger speakers you will hear a dramatic reduction of bass if the speakers are out of phase.

**NOTE:** Once each channel pair is adjusted, they cannot be separated. Any change of phase must be done by the pair.

**Phasing the Pairs:** Again, listening to a single vocalist. Mute all channels again except the tweeters. Then bring in the midranges. If these pairs are in proper phase the sound should be near center in the upper part of the windshield. If they are not in phase the sound will be pulled down lower. You can reverse the phase of BOTH mids now and listen for the difference in the sound location. Choose the phase position that puts the sound high near the center.

Once you have these phased you can bring in the mid-bass with the same process. Again, the focus should be high in the dash. If the mid-bass is out of phase with the tweeters and mids then they will pull the sound down toward the floor.

**Woofers or Subs:** There will be bass! You have phased the woofers, so we know there will be bass. What you need to listen for here is location, and mid-bass. (something with kick drums is ideal). Proper woofer phasing will work with the mid-bass drivers to give good solid, crisp mid-bass. Out of phase will result in a soft, low-impact mid-bass. Bass out of phase with the mid-bass will also be more located in the back of the vehicle while a properly phased bass will blend better into the front soundstage.

# Tuning - The Simple Rules

*Before you can get what you want, you need to know what you want. In the graphs below, we look at some different response curves and what they mean and sound like.*

*Keep in mind that these illustrations are NOT what your EQ graph looks like. They are what your RTA looks like. If you have a flat response like below on your RTA, your EQ graph will have lots high spots and low spots to make the RTA graph look like that.*

**Flat is not the goal:** *Generally, a flat response will give a sound lacking in bass and will sound harsh on the high end and a little "thin" without a lot of body.*

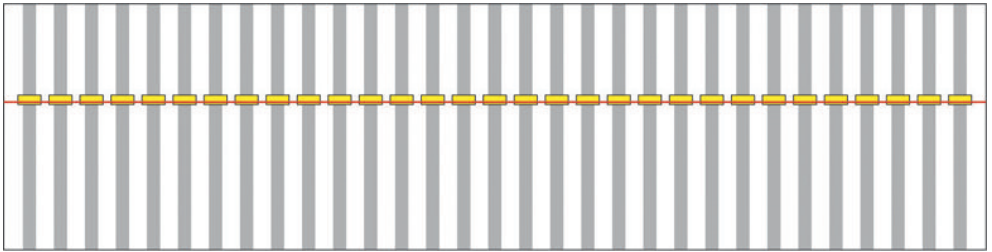

**An Excellent Response Curve:** *Here is a curve that will almost always sound superb in a vehicle. The bass area is 3 to 4dB above the midrange and the highs slope off smoothly. This will have good solid bass and a smooth sound through the midrange and highs.*

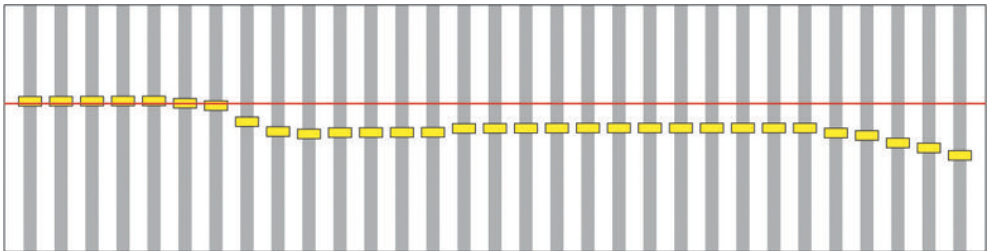

**Problem Curve:** Here is a problem curve. The small variations in blue are OK. They are 2dB or less and you likely will never hear them. However, the variations in the red circles are bad. While the ear is not so sensitive to dips in the response, it is very sensitive to peaks. The response peaks are what makes a speaker sound "harsh" and cause "ear fatigue" (You listen for a while then turn it off because it starts to irritate your ears). With this curve you want to pull down those peaks to put them in line with the rest of the signal response. Once that is done the system should sound just about right.

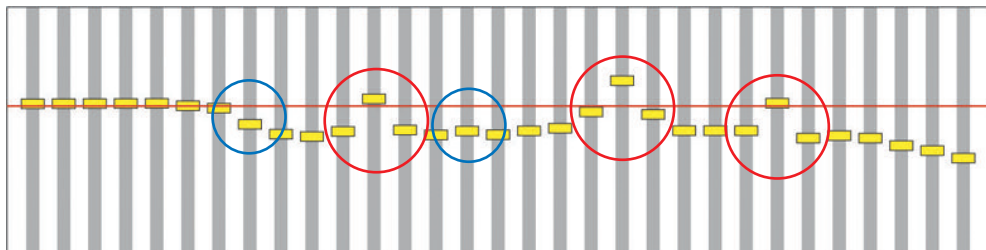

## Dash Board Control

The Player is controlled by an 3" Touch Screen color display. It is housed in an elegant aluminum CNC case and it can also be used to control volume, fader, balance, tone, some set-up of the system, and to switch instantaneously, by touch screen, from different tuning presets (up to 10 memory presets).



The front page of the Dashboard shows the basic functions. The top row shows the active inputs available. The input classes are **HD Player**, **Radio/CD**, and **Line/Digital**. Inputs not active will not show in this row. If you have several digital and line inputs, they will drop-down under the Line/Digital box. The front page also shows current Battery Voltage, and system Volume Level. At the lower right you can choose English or Chinese as display languages.

**NOTE:** A quick push on the dashboard volume knob puts the system in Mute. Tap again to Un-Mute.

The lower row also shows **System**, for informations about the system status and other functions, and **Audio** for limited audio controls for on-the-fly adjustments.

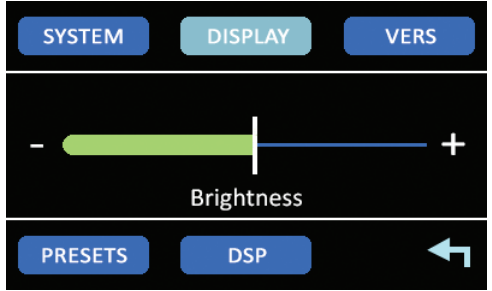
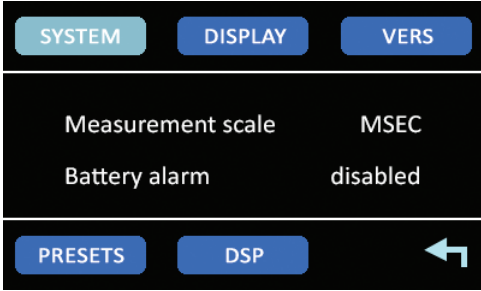

*SYSTEM shows some information about the system status and other functions. The page allows you to choose DISPLAY to adjust the brightness of the Dashboard display.*

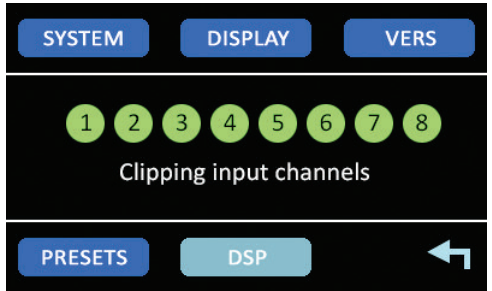
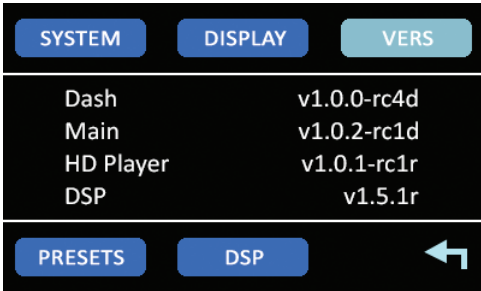

*VER will show you the Software and Firmware versions of the processing components currently installed. DSP brings up clipping indicators for each of the 8 input channels. The System menu also includes the PRESETS list. The up/down arrows move the list while the white bar remains fixed. When the desired memory preset is found you tap the white bar. Then click CONFIRM to load that preset. The arrow in the lower corner returns to the previous page.*





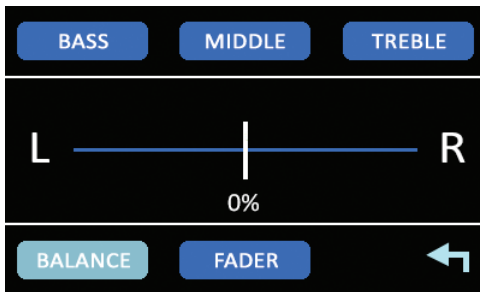
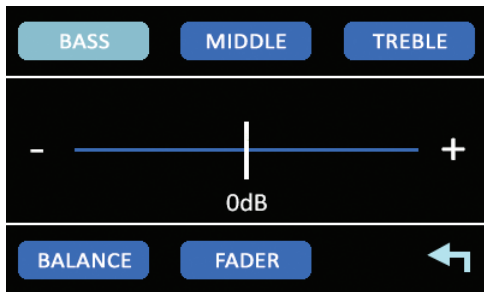

The AUDIO page gives you adjustments for balance and fader, and for Bass, Midrange and Highs. The arrow in the lower corner returns to the previous page.

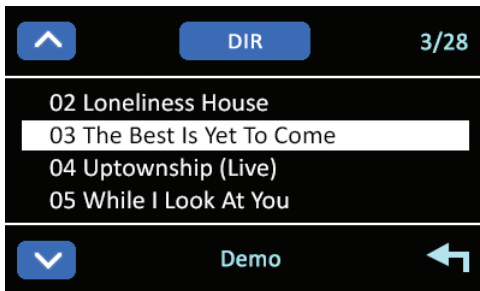

When you choose HD PLAYER you will get the directory. The directory shows files loaded singly and also folders. If you open a folder, you get a list of the files inside. Choices here are made using arrows to find the desired item then tapping the item. The folder is shown at the bottom. When a piece is playing you see the file type and track informations.

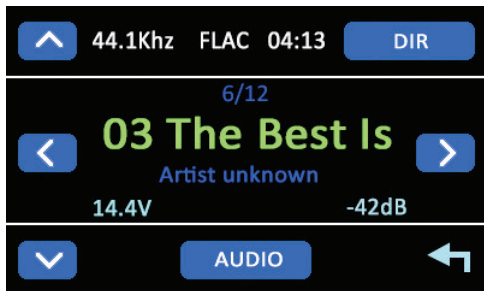

# Formatting Larger USB Thumb Drives/Sticks

Of course, before you play HD Music you have to have the HD files. There are many download sites where you can get the files (HDTracks.com is just one). You need to download the files onto a USB drive. The USB drive needs to be formatted to FAT32 with a limited space memory of 2 TB. Most USB drives are formatted this way but you can check by right clicking the USB drive in File Explorer and choosing Format. That will bring up a formatting menu and show the current file system on the drive. If it's FAT32 you can exit out. If not, then you can choose FAT32 from the menu and reformat. Be aware that formatting will remove any files already on the drive.

FAT32 is the most used "file system" for external/removable drive, USB drive, or SD card. The HDSP processors only works with USB drives formatted FAT32. The maximum archive limit that HDSP-V can handle is 2TB. W-10 can format (as standard available tool) <32GB. If we use a USB drive <32GB, the Windows menu will show FAT32 (among the others) as Default. If we insert a >32GB USB drive, the Default is exFAT, and the FAT32 field is NOT present. Formatting a USB drive >32GB to FAT32 must be done by partitions with a 3rd party program.

There are a number of programs which you can download from the internet that will allow you to format the larger USB drives to FAT32 quickly. While you can format larger USD Drives to FAT32 using the Windows Power Shell, it takes a very long time. One good program is GUIformat.exe which can be downloaded here. <http://www.ridgecrop.demon.co.uk/index.htm?guiformat.htm>

GUIformat.exe is a portable app and does not need to be installed on the computer you can simply place it on your desktop and use it. (Tip below is from Website "Howtogeek")

Click on the guiformat.exe file and in the **FAT32 Format** window, select the drive to format and type a volume label, if you want to have one.

Select the **Quick Format** option, and then click the **Start** button.

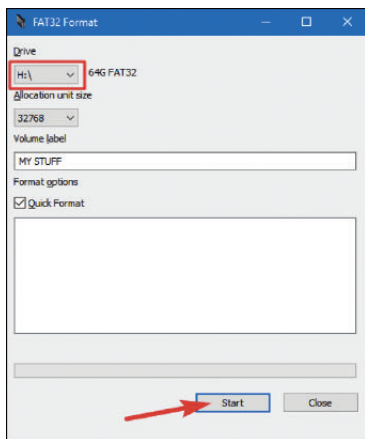

A window pops up to warn you that all data on the drive will be lost when you format. Click "OK" to format the drive.

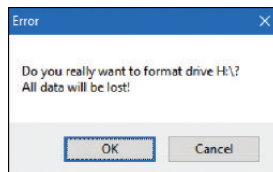

This tool took a few seconds to format our 64GB USB drive that took us over an hour in PowerShell.

# Special Features of the HDSP-Z16V Processor

*The unique I/O page of the HDSP-Z16V processor allows some useful special effects to happen.*

*A little about how it all works:*

- a. You can assign any combination of inputs to any processing channel by adding or subtracting inputs (you subtract but adding an input with its phase reversed).*
- b. As mentioned earlier, even though there are nominally only 8 input channels, the actual processor is using 12 channels of input in three groups. There can be 2~8 channels in Gp1, 2 channels only plus the on-board HD player in Gp2, and 2 Channels in Gp3, which is the Loop function. The Loop inputs are not taken from an outside source but are taken from the output of the other 2 groups.*

*With this information you can create realistic ambience, create a realistic center channel, and you can even create a pair of 60-band EQ channels.*

## **Ambient Rear Fill**

*For years the problem with rear fill has been that it destroys the front stage. This is because the front and rear have exactly the same information. When the rear is loud enough for you to hear it, the front stage is no longer out in front and your head is being drawn to the rear.*

*At a concert the center stage information comes straight to you, but the information at the sides of the stage has more reflected information and a later arrival time, especially if it is arriving after reflecting off the back walls. The channel then is to remove the outside information from the rear channels and to add the delay needed to simulate the desired hall size. Two things here help you do just that very effectively as in the next page screen.*

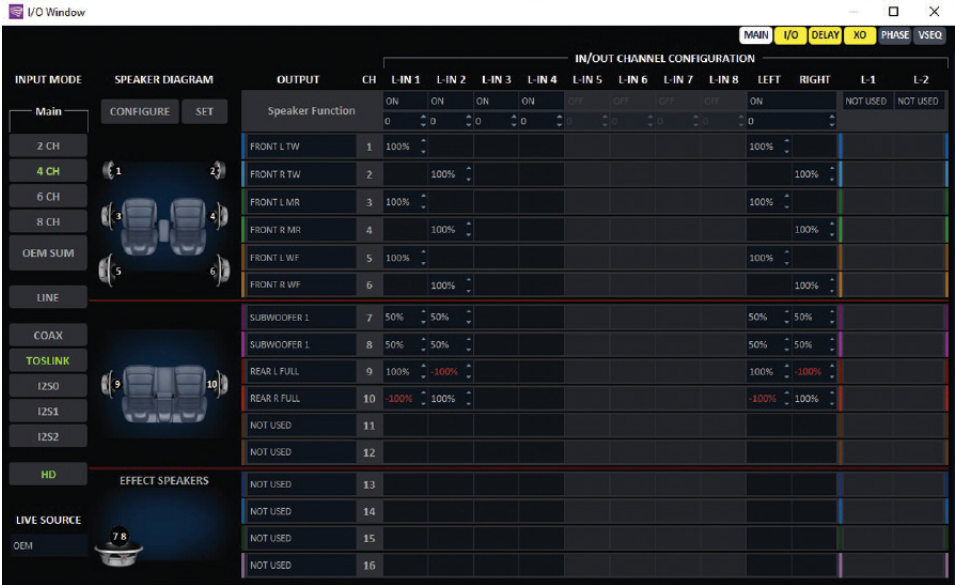

1. You can remove the Right Ch information from the Left channel and remove the Left Ch information from the Right channel by reversing the phase of the added channel. So Right is added out of phase to the Left and Left is added out of phase to the Right, without the center channel information. The rear information is no longer the same as the front information.
2. Secondly, you need to be able to provide enough delay so the rear information arrives when it would in a hall or stadium environment. While most processors give you 20 to 25ms of delay, the HDSP processor give you up to 50, or even 100ms of delay so you can make the ambient effect feel as large as you want.

**CRITICAL NOTE** For Loop Function: When using the Loop Function, the loop must originate from Channels 9~16, and be looped back into Channels 1~8.

See **WHY THE LOOPS WORK AND HOW** in the next pages.

## Creating a Pair of 60-Band Equalizer Channels

The Loop function of the HDSP-Z16 V can also be used to create a pair of 60-band EQ channels, This will allow ultimate fine tuning of systems (especially in competition) that use wide-range speakers for the midrange and high frequencies.

The screenshot displays the 'I/O Window' configuration for the HDSP-Z16 V. The interface is divided into several sections:

- Main:** Includes buttons for 'CONFIGURE' and 'SET'.
- SPEAKER DIAGRAM:** Shows a speaker layout with numbered outputs 1, 2, 3, and 4.
- OUTPUT:** Lists speaker functions for each channel, such as 'FRONT L TW', 'FRONT R TW', 'FRONT L WF', 'FRONT R WF', and 'SUBWOOFER 1'.
- IN/OUT CHANNEL CONFIGURATION:** A table with columns for 'CH', 'L-IN 1' through 'L-IN 8', 'LEFT', 'RIGHT', 'L-1', and 'L-2'. It shows gain settings (e.g., 100%, 50%) and 'ON'/'OFF' status for each channel.
- COAX:** Includes 'TOSLINK' and 'I2S0' through 'I2S2' options.
- HD:** Includes 'EFFECT SPEAKERS'.
- LIVE SOURCE:** Includes 'OEM' and '568' options.

CH	L-IN 1	L-IN 2	L-IN 3	L-IN 4	L-IN 5	L-IN 6	L-IN 7	L-IN 8	LEFT	RIGHT	L-1	L-2
0	ON	ON	OFF	OFF	OFF	OFF	OFF	OFF	ON		Out 09	Out 10
1	100%								100%		100%	
2		100%								100%		100%
3	100%								100%			
4		100%								100%		
5	50%	50%							50%	50%		
6	50%	50%							50%	50%		
7	50%	50%							50%	50%		
8	50%	50%							50%	50%		
9	NOT USED								100%			
10	NOT USED									100%		
11	NOT USED											
12	NOT USED											
13	NOT USED											
14	NOT USED											
15	NOT USED											
16	NOT USED											

Here we have used Channels 9/10 to form the loop. Notice that they are labeled and Not Used because we do not want the RCA output of those channels. They are pooped back into channels 1 and 2 so channels 1 and 2 both have 60-band equalizers.

Note that when you create a 60 band you will want to equalize all even bands on the target channels (in this case 1/2), and all odd bands on the looped channels (in this case 9/10).

### *WHY THE LOOPS WORK AND HOW*

*The signal paths for the loop functions can be made in the analog world using RCA Patch cords. Unfortunately, that doesn't work right and consequently it doesn't sound right. The problem is time, and when there is a problem with time there is a problem with phase. When you create a loop with patch cords, you are feeding a signal back into the processor a full processing cycle behind where it started and mixing it out of time with another signal. To solve this problem the program must delay all the other signals so the looped signal will be correct in time and phase.*

*Secondly: The lower the frequency, the more processing power it takes to reproduce them accurately. So, to save processing power, the common practice is to simply down-sample the lower frequencies on the assumption that you will never know. Zapco has taken a different approach, we absolutely loaded up power on bands 1~15 with double precision filters because if you want it to sound right you can't just do the easy stuff. So, when you set up a 60-band EQ, you want bands 1~15 of both the target channel and the Loop channel to be in the low frequencies and bands 16~30 to be in the higher frequencies.*

*Also: You will notice that Bands 1~15 can go anywhere in the frequency spectrum while Bands 16~30 must stay above 630 Hz. This is to avoid sound imperfections that can result from using the higher band filters in the low frequencies.*

*Everything we have done with the HDSP processors has been done to make this the best sounding DSP.. period.*

# Firmware Update

Standard procedure with new digital equipment is to check for updates. The current software and firmware for the HDSP processors will always be on the HDSP support page. When you open your GUI you will see the current installed software version. When you turn on the HDSP and go to System on the Dash Controller you will find the firmware version currently installed in the HDSP. The HDSP processor is and will continue to be an evolving product, and as such will be updated occasionally. In some cases, the update will be only software. However as new functions are developed there will be updates to the firmware as well.







**Upgrading the Firmware** must be done in the correct order to be successful. The firmware should be downloaded from the web site on the HDSP-V Support Page.

Two Items will be under Firmware on the support page.

- **ACPUUpgrade v1.2.0.** This is the upgrade tool
- **Firmware Update file** which is a .pkg file. This is the upgraded Firmware Package

Installation:

- First Step is to connect the PC to the HDSP
- Remove the USB-A Key (HD Music Files)
- Make sure no music is playing on any input sources and volume is fully down on the head unit
- Turn on the system
- Open the ACPUpgrade v1.2.0 folder and find the files below

Name	Date modified	Type	Size
 ACPUpgrade.exe	1/31/2019 1:47 AM	Application	33 KB
 Communication.dll	1/31/2019 1:39 AM	Application extension	36 KB
 Ionic.Zip.dll	9/28/2017 9:27 AM	Application extension	481 KB
 Platform.dll	1/31/2019 1:39 AM	Application extension	113 KB
 Protocol.dll	1/31/2019 1:39 AM	Application extension	19 KB
 Util.dll	1/30/2019 8:02 AM	Application extension	21 KB

- Click on the .exe file to open the System Upgrade Tool below

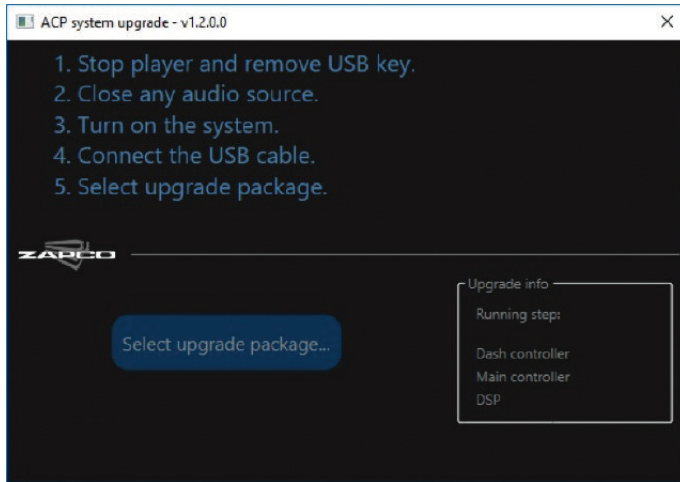

- Double check items 1 through 4 below to assure it is ready for the update
- Choose Select upgrade package and navigate back to your Downloads to find HDSP-Firm\_v1.0.7 (or the current version)
- In the folder, open the subfolder Firmware File v1.0.7 (or the current version) and click on the .pkg file to begin the update.

The upgrade will proceed in several steps to upgrade the Dash Controller, the Main System Controller and the DSP chips. When the update is finished it will notify you that the update has been successful.



# Technical Specifications

---

<b>DSP Processor</b>	OMAP L-138 - 2 x 456 MHz - 32 Bit (till 64-bit / IEEE double precision) Processor Point: Fixed & Floating Sampling Rate: 96 KHz (HDSP-Z16V), 192 KHz (HDSP-Z8V)
<b>Player Power</b>	456 Mhz - Arm 9 32 Bit
<b>Audio Formats</b>	WAV, AIF, AIFF, FLAC, ALAC, AAC, MP3
<b>ADC</b>	Standard: AK5558, 32 Bit, 784 KHz, DR 115 dB Option B: AK5578, 32 Bit, 784 KHz, DR 121 dB
<b>DAC</b>	Standard: AK4458, 32 Bit, 784 KHz, DR 115 dB (*8ch) Option B: AK4490, 32 Bit 784 KHz, DR 120 dB (*8ch) Option A: ES9038PRO, 32 Bit, 784 KHz, DR 132 dB (*8ch)
<b>S/N Floor Noise</b>	-125 dB (from 20 Hz to 20 KHz) -135 dB (from 150 Hz to 20 KHz) -140 dB (average from 80 Hz to 20 KHz)
<b>Crosstalk</b>	100 Hz/100 dB - 1 KHz/115 dB - 10 KHz/100 dB (average all channels)
<b>Frequency Response</b>	5Hz @ 45 KHz (HDSP-Z16V), 5Hz @ 90 KHz (HDSP-Z8V)
<b>Analog IN</b>	6/8 x RCA Low Level 1/5 Volt RMS, 5KOhm, Gain Control, Clipping LED 8 x High Level 4/20 Volt, 200 Ohm, Gain Control, Clipping LED S/N Ratio: from 109 to 115 dB A THD+N: 0,001, 1V Out (HDSP-Z16V), 0,0008, 1V Out (HDSP-Z8V)
<b>Digital IN</b>	Optical: 24 Bit - 192 KHz SPDIF: 24 Bit - 192 KHz 3 x i2S: 24 Bit - 192 KHz S/N Ratio: from 115 to 120 dB A THD+N: 0,0008 (HDSP-Z16V), 0,0006 (HDSP-Z8V)
<b>Analog OUT</b>	16 x RCA (HDSP-Z16V), 8 x RCA (HDSP-Z8V), 4 Volt RMS
<b>Equalizer</b>	Parametric 30/6 poles (HDSP-Z16V), 15 poles (HDSP-Z8V)
<b>Phase Filter</b>	All channels 1Hz/1 Degree step
<b>VSEQ Filter</b>	50-200 Hz - 1 Hz step
<b>Dash Board</b>	3" Double speed Touch Screen, Resolution 240 x 400 px, cable 5 mt Controls: HDPlayer/Volume/Balance/Fader/Tone/Presets
<b>Wireless</b>	Wi-Fi External Module (included), cable 1 mt External aptX HD Module (optional, Qualcomm CSR8675)
<b>Connections</b>	PC/Dash Board: USB-B / RJ45
<b>USB (Audio)</b>	Memory stick formatted FAT32, with a limited space memory of 2 TB
<b>Power Supply</b>	Operating: 6-16 Volt, Stop-Start ignition system support, Fuse 1A
<b>Dimensions (mm)</b>	Main Unit: 217(L) x 164(W) x 57(H), Dash Board: 111(L) x 16(W) x 49(H)



Apex, Aprilia ITALY  
Since 1974

[zapco.com](http://zapco.com)