

Z-AP SERIES
Owner's Manual



Table of Contents

General instructions	4
<i>IT Istruzioni Generali</i>	
<i>DE Allgemeine Anweisungen</i>	
<i>FR Instructions Générales</i>	
<i>ES Instrucciones Generales</i>	
<i>CH 常规安装指引</i>	
Committed to excellence	7
The Zapco Z-AP Series	8
Class, Power, Heat	10
All wire is not created equal	12
Amplifiers Controls	14
Speaker Wiring	16
Technical Specifications	19

EN General Instructions

The installation of the product must be done by professional technicians. Always contact a ZAPCO Authorized Dealer.

Before you start your installation

ZAPCO highly recommends that a fuse or circuit breaker be placed within 18" of the battery. The protection device should be placed where it can be accessed easily and all wiring should be routed safely and correctly according to the following guidelines:

- Do not run wiring close to hot or spinning objects
- Always use wire grommets when routing wire through the firewall or any other metal panels
- Make sure that the potential for pinched wiring is avoided by routing all wires away from moving objects, including brake, gas and clutch pedals, etc.

Planning your power connections

- The +12V B is the main power input. This must be connected the vehicle battery's positive (+) terminal
- The GND is the main ground or negative connection. This must be securely attached to bare metal at the vehicle frame
- The terminal between the main power and ground is the +12 turn-on input (REM) and can be connected to the head unit turn-on output wire. If none is available it can be connected to an accessory (ACC) terminal

Mounting your amplifier

Mounting your Zapco amplifier is easy. Just keep in mind a few guidelines:

- The amplifier requires adequate ventilation. Creating power creates heat, and cooling requires air
- Keep the amplifier out of the engine compartment or other locations that may cause excessive heat or moisture
- Do not mount the amplifier to a subwoofer box or other place that may have excessive vibration

Setting Gains

Gain pots are not volume controls and should be used only if absolutely necessary. Turning up gain controls causes increased noise, makes distortion more likely and reduces the dynamic range of your system.

Continuous exposure to excessive sound pressure levels may cause hearing damage. ZAPCO strongly advises that you use common sense when setting volume levels. Everything written in this manual is for the proper use of the products. Some features or specifications could be modified during production to improve the product performance. The technical specifications and functionalities stated here are current as of the time of publication.

IT Istruzioni Generali

L'installazione del prodotto deve essere effettuata da tecnici professionisti. Rivolgersi sempre ad un Rivenditore Autorizzato ZAPCO.

Prima di iniziare l'installazione

ZAPCO consiglia vivamente di posizionare un fusibile entro 18" dalla batteria. Il dispositivo di protezione deve essere posizionato in u punto di facile accesso e tutti i cablaggi devono essere instradati in modo sicuro e corretto secondo le seguenti linee guida:

- Non eseguire il cablaggio vicino ad oggetti caldi o taglienti*
- Utilizzare sempre i passacavi quando si in strada il cavo attraverso pannelli metallici*
- Assicurarsi che venga evitato il rischio di schiacciamento dei cavi allontanando tutti i cavi da oggetti in movimento, inclusi i pedali del freno, dell'acceleratore e della frizione, etc.*

Pianificare l'alimentazione

- Il +12V B è l'ingresso di alimentazione principale. Questo deve essere collegato al terminale positivo (+) della batteria dell'auto*
- Il GND è la massa principale o il collegamento negativo. Questo deve essere fissato saldamente al metallo del telaio del veicolo*
- Il terminale tra l'alimentazione principale e la massa è l'ingresso di accensione +12 (REM) e può essere collegato al cavo di uscita di accensione dell'unità principale. Se non è disponibile, può essere collegato ad un terminale accessorio (ACC)*

Installare l'amplificatore

Installare il tuo amplificatore Zapco è facile. Basta tenere a mente alcune linee guida:

- L'amplificatore richiede una ventilazione adeguata. Creare potenza crea calore ed il raffreddamento richiede aria*
- Tenere l'amplificatore fuori dal vano motore o altri luoghi che potrebbero causare calore o umidità eccessivi*
- Non installare l'amplificatore su un subwoofer o in un altro posto che potrebbe generare vibrazioni eccessive*

Regolazione guadagni

I potenziometri di guadagno non sono controlli del volume dovrebbero essere usati solo se assolutamente necessario. Aumentare il guadagno provoca un aumento del rumore, distorsione e riduce la gamma dinamica.

L'esposizione continua a livelli di pressione sonora eccessivi può causare danni all'udito. ZAPCO consiglia vivamente di utilizzare il buon senso quando si impostano i livelli di volume. Tutto quanto scritto in questo manuale è finalizzato al corretto utilizzo dei prodotti. Alcune caratteristiche o specifiche possono essere modificate durante la produzione per migliorare il prodotto. Le specifiche tecniche e le funzionalità qui riportate sono aggiornate al momento della pubblicazione.

DE Allgemeine Anweisungen

Die Produktinstallation sollte von professionellen Technikern durchgeführt werden. Wenden Sie sich immer an einen Autorisierten ZAPCO-Händler.

Bevor Sie mit der Installation beginnen

ZAPCO empfiehlt dringend, eine Sicherung innerhalb von 18 Zoll von der Batterie zu platzieren. Der Schutz muss an einer leicht zugänglichen Stelle angebracht werden und die gesamte Verkabelung muss gemäß den folgenden Richtlinien sicher und korrekt verlegt werden:

- Verkabeln Sie das Gerät nicht in der Nähe von heißen oder scharfen Gegenständen*
- Bei der Kabeldurchführung immer Kabelverschraubungen verwenden Metallplatten*
- Stellen Sie sicher, dass die Gefahr eines Einklemmens des Kabels vermieden wird, indem Sie alle Kabel von sich bewegenden Objekten fernhalten, einschließlich Brems-, Gas- und Kupplungspedale usw*

Planen Sie die Stromversorgung

- +12V B ist der Hauptstromeingang. Dieser muss an den Pluspol (+) der Autobatterie angeschlossen werden*
- Der GND ist die Hauptmasse oder negative Verbindung. Dieser muss sicher am Metall des Fahrzeugchassis befestigt sein*
- Der Anschluss zwischen Hauptstrom und Masse ist der Zündeingang +12 (REM) und kann an die Zündausgangsleitung des Hauptgeräts angeschlossen werden. Wenn es nicht verfügbar ist, kann es an ein Zubehörterminal (ACC) angeschlossen werden*

Installieren Sie den Verstärker

Die Einrichtung Ihres Zapco-Verstärkers ist einfach. Beachten Sie einfach ein paar Richtlinien:

- Der Verstärker benötigt eine ausreichende Belüftung. Bei der Stromerzeugung entsteht Wärme, für die Kühlung ist Luft erforderlich*
- Bewahren Sie den Verstärker außerhalb des Motorraums oder anderer Orte auf, an denen übermäßige Hitze oder Feuchtigkeit entstehen könnte*
- Installieren Sie den Verstärker nicht auf einem Subwoofer oder an einem anderen Ort, der übermäßige Vibrationen erzeugen könnte*

Verstärkungsanpassung

Gain-Potentiometer sind keine Lautstärkeregler, sie sollten es sein nur dann verwendet werden, wenn dies unbedingt erforderlich ist. Eine Erhöhung der Verstärkung führt zu mehr Rauschen und Verzerrungen und verringert den Dynamikbereich.

Ständige Einwirkung übermäßiger Schalldruckpegel kann zu Gehörschäden führen. ZAPCO empfiehlt dringend, beim Einstellen der Lautstärke den gesunden Menschenverstand zu nutzen. Alles, was in diesem Handbuch geschrieben wird, zielt auf die korrekte Verwendung der Produkte ab. Einige Funktionen oder Spezifikationen können während der Produktion geändert werden, um das Produkt zu verbessern. Die hier gezeigten technischen Spezifikationen und Funktionen sind zum Zeitpunkt der Veröffentlichung aktuell.

FR Instructions Générales

L'installation du produit doit être effectuée par des techniciens professionnels. Contactez toujours un Revendeur agréé ZAPCO.

Avant de commencer votre installation

ZAPCO recommande fortement qu'un fusible ou un disjoncteur soit placé à moins de 18 pouces (moins de 45 centimètres) de la batterie. Le dispositif de protection doit être placé là où il est facilement accessible et tout le câblage doit être acheminé en toute sécurité et correctement selon les directives suivantes:

- Ne faites pas passer le câblage à proximité d'objets chauds ou en rotation*
- Utilisez toujours des passe-fils lorsque vous faites passer le fil à travers le pare-feu ou tout autre panneau métallique*
- Assurez-vous que tout risque de pincement des câbles soit évité en acheminant tous les fils loin des objets en mouvement, y compris les pédales de frein, d'accélérateur, d'embrayage, etc.*

Planification de vos connexions électriques

- Le +12V B est l'entrée d'alimentation principale. Celui-ci doit être connecté à la borne positive (+) de la batterie du véhicule*
- Le GND est la masse principale ou connexion négative. Celui-ci doit être solidement fixé au métal nu sur le châssis du véhicule*
- La borne entre l'alimentation principale (+12V B) et la masse (GND) est l'entrée de mise sous tension +12 (REM) et peut être connectée au fil de sortie de mise sous tension de l'unité principale. Si aucun n'est disponible, il peut être connecté à une borne accessoire (ACC). Vous devez éviter d'utiliser des fils d'allumage (IGN), car ils peuvent être bruyants*

Montage de votre amplificateur

Le montage de votre amplificateur Zapco est facile. Gardez simplement à l'esprit quelques directives:

- L'amplificateur nécessite une ventilation adéquate. La création d'énergie crée de la chaleur et pour le refroidissement on nécessite de l'air*
- Gardez l'amplificateur hors du compartiment moteur ou de tout autre endroit susceptible de provoquer une chaleur ou une humidité excessive*
- Ne montez pas l'amplificateur sur un caisson de basses ou dans tout autre endroit susceptible de générer des vibrations excessives*

Définition des gains

Les potentiomètres de gain ne sont pas des commandes de volume. Augmenter les commandes de gain entraîne une augmentation du bruit, rend la distorsion plus probable et réduit la plage dynamique de votre système.

Une exposition continue à des niveaux de pression sonore excessifs peut provoquer des lésions auditives. ZAPCO vous conseille fortement de faire preuve de bon sens lors du réglage des niveaux de volume. Tout ce qui est écrit dans ce manuel est destiné à la bonne utilisation des produits. Certaines caractéristiques ou spécifications pourraient être modifiées en cours de production pour améliorer les performances du produit. Les spécifications techniques et les fonctionnalités indiquées ici sont à jour au moment de la publication.

ES Instrucciones Generales

La instalación del producto debe ser realizada por técnicos profesionales. Comuníquese siempre con un Distribuidor Autorizado ZAPCO.

Antes de comenzar su instalación

ZAPCO recomienda encarecidamente colocar un fusible o disyuntor a 18 pulgadas (menos de 45 cm) de la batería. El dispositivo de protección debe colocarse en un lugar de fácil acceso y todo el cableado debe tenderse de forma segura y correcta de acuerdo con las siguientes pautas:

- No tienda cables cerca de objetos calientes o giratorios*
- Utilice siempre pasacables cuando pase el cable a través del cortafuegos o cualquier otro panel metálico*
- Asegúrese de evitar la posibilidad de que los cables queden atrapados colocando todos los cables lejos de objetos en movimiento, incluidos los pedales de freno, acelerador, embrague, etc.*

Planificación de sus conexiones eléctricas

- El +12V B es la entrada de alimentación principal. Este debe conectarse al terminal positivo (+) de la batería del vehículo*
- El GND es la conexión a tierra principal o negativa. Este debe estar firmemente sujeto al metal desnudo en el marco del vehículo*
- El terminal entre la alimentación principal (+12V B) y tierra (GND) es la entrada de encendido +12 (REM) y se puede conectar al cable de salida de encendido de la unidad principal. Si no hay ninguno disponible, se puede conectar a un terminal accesorio (ACC). Debes evitar el uso de cualquier cable de encendido (IGN), ya que pueden ser ruidosos*

Montaje de su amplificador

Montar su amplificador Zapco es fácil. Solo tenga en cuenta algunas pautas:

- El amplificador requiere una ventilación adecuada. La creación de energía genera calor y la para la refrigeración se requiere aire*
- Mantenga el amplificador fuera del compartimiento del motor u otros lugares que puedan causar calor o humedad excesivos*
- No monte el amplificador sobre una caja de subwoofer u otro lugar que pueda tener vibraciones excesivas*

Configuración de ganancias

Los potenciómetros de ganancia no son controles de volumen. Antes de encender su sistema por primera vez, debe asegurarse de que todos los controles de ganancia estén configurados al mínimo. Los controles de ganancia deben usarse sólo si es absolutamente necesario. Subir los controles de ganancia provoca un aumento del ruido, aumenta la probabilidad de distorsión y reduce el rango dinámico de su sistema. Si su unidad principal no tiene suficiente salida, obtendrá resultados mucho mejores si invierte en un amplificador de línea para proporcionar más señal al amplificador.

La exposición continua a niveles excesivos de presión sonora puede causar daños auditivos. ZAPCO recomienda encarecidamente que utilice el sentido común al configurar los niveles de volumen. Todo lo escrito en este manual es para el uso adecuado de los productos. Algunas características o especificaciones podrían modificarse durante la producción para mejorar el rendimiento del producto. Las especificaciones técnicas y las funcionalidades aquí indicadas están actualizadas en el momento de la publicación.

CH 常规安装指引

产品的安装必须由熟练的技术人员完成。请始终联系 ZAPCO 授权经销商。

开始安装前

ZAPCO强烈建议在电池附近的18英寸（约45.7厘米）内放置一个保险丝或断路器。保护装置应放置在易于触及的位置，所有布线应根据以下准则安全正确地布置:

- 不要将电线靠近热源或旋转物体*
- 在将电线引导穿越防火墙或任何其他金属面板时，务必使用电线防护套*
- 确保所有电线远离汽车可以移动的部件，包括刹车，油门和离合踏板等，以避免电线被夹*

电源连接的准备工作

- +12V B是主要的电源输入，必须连接到车辆电池的正极（+）端*
- GND是主要的接地或负极连接。必须牢固地连接到车辆车架上的裸露金属部位*
- 主电源和地之间的端子是+12转换输入（REM），可以连接到主机的开关输出线。如果没有可用的线，它可以连接到附件（ACC）终端。应避免使用任何点火（IGN）线，因为这可能会产生噪音*

安装功放机

安装 ZAPCO 功放机非常简单。只需记住一些准则:

- 功放机需要足够的通风。因为产生功率会产生热量，冷却需要空气*
- 不要将功放机安装在发动机舱或可能产生过多热量或湿气的位置*
- 不要将功放机安装在低音炮音箱或其他可能有过多振动的地方*

设置增益

增益旋钮不是音量控制。在首次启动系统之前，应确保所有增益控制设置为最小值。增益控制只应在绝对必要的情况下使用。增大增益控制会导致噪音增加，增加失真的可能性，并降低系统的动态范围。如果您的主机输出不足，最好购买信号放大器以向功放机提供更多信号，从而获得更好的音效。

长时间暴露于过高的声压级可能会导致听力损伤。ZAPCO 强烈建议在设置音量水平时要注意保护听力。本手册中的所有内容都是为了正确使用产品而编写的。一些功能或规格可能会在生产过程中进行修改以提高产品性能。此处陈述的技术规格和功能只针对本手册出版日期期间的功放机产品

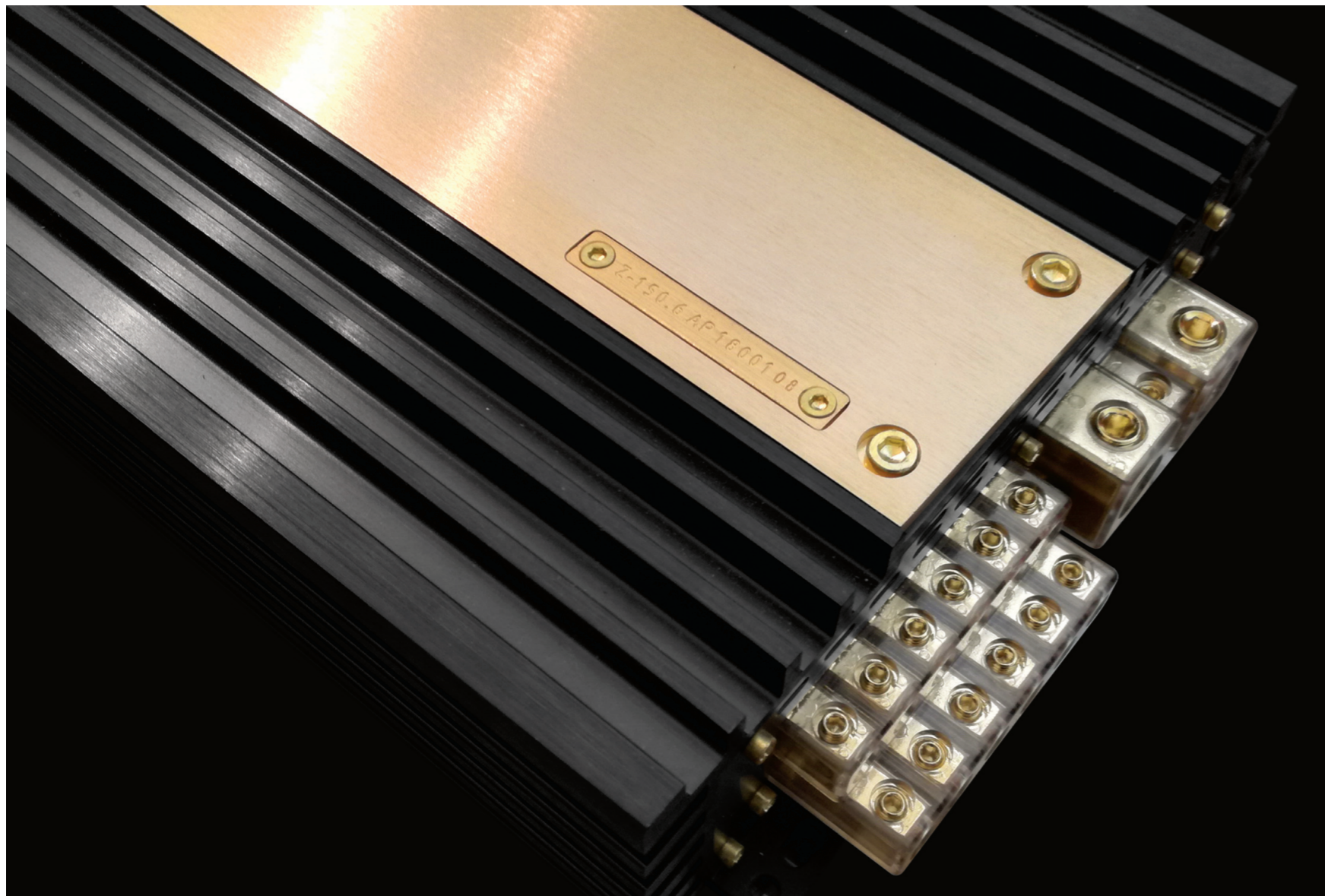

Committed to excellence

Audiophile: An audio fanatic whose sole passion is accurate sound reproduction that brings all the purity of a live performance to recorded music. It is a familiar term with high-end home gear, but a term always considered unattainable in the automotive environment. Zapco disagrees! In 1974 Zapco began a quest for perfect sonic reproduction. In 2000 we introduced the C2K Competition amplifiers and by 2003 Zapco accounted for over 33% of ALL awards at the IASCA Car Audio Finals. In 2012 we introduced the new Z-Series amps with high end internal components matched for pure sound quality. This was our first line developed by listening rather than by measuring. That series was favorably compared to the best home amps, and quickly went straight to the winner's circle in Audio contests. They were called the best Zapco ever. How did we respond? We said "thank you, but we think we can do even better". And we did. We upgraded to the newest audiophile caps and op-amps, redesigned the power supply, and made board modifications to create the Z-Series LX amps. Not only did they top the car audio comparisons, but home speaker makers even brought their speakers to our CES suite to demonstrate what their speakers could do. The LX was beating their demo home amps in sound quality. How did Zapco respond? We said "thank you, but we think we can do even better". And we did! With the Z-AP Series we built an amplifier to set new sound quality standards

The Zapco Z-AP Series

With the Z-AP Series we built an amplifier to set new sound quality standards. How did we do it? We took the best of the LX amp and we tweaked the circuitry. We used the same high-end audio quality electrolytic caps in the power supply that we used in the LX amplifiers. In the Signal path we replaced the electrolytics with the high-end WIMA poly caps. We used a new low noise, audio op-amp for the input stage and the smoothest audio op-amp we could find for the signal path (the right op-amp for the right job). We doubled the output drivers, and increased the operating voltage of the matched final output devices. To get heat off the output devices faster, and increase efficiency, we used a new insulator material developed for aerospace. At the differential input stage, we used 0.1% resistors to assure the lowest possible floor. We developed our own patented, multi ground RCA connectors with extra heavy gold plating for perfect signal transfer. We even improved the low noise gain pots had added detents to make watching levels a breeze. To top it all off, we gave it a new look, with a matt black finish and a solid copper plate with the logo and serial number engraved right in for posterity. The Result: The ultimate SQ amplifier designed by listening with ears and much as by measuring. So we get the possible smoothest, purest overall sound quality and, at the same time, a signal to noise ratio of over 110dB, so you get all that pure sound quality in even the quietest of musical passages.

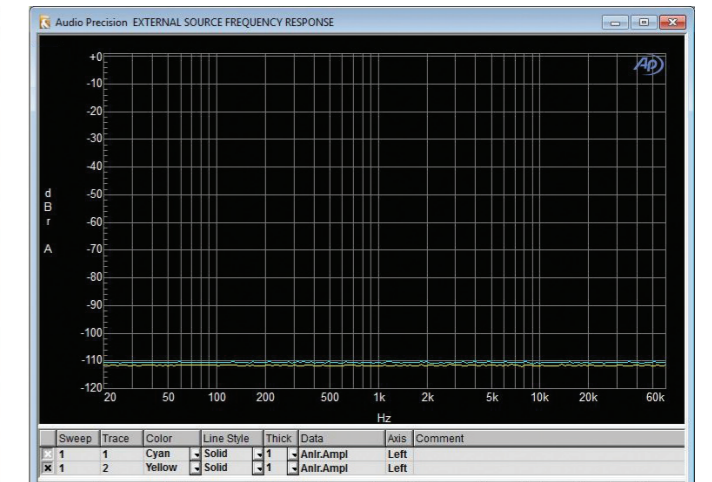
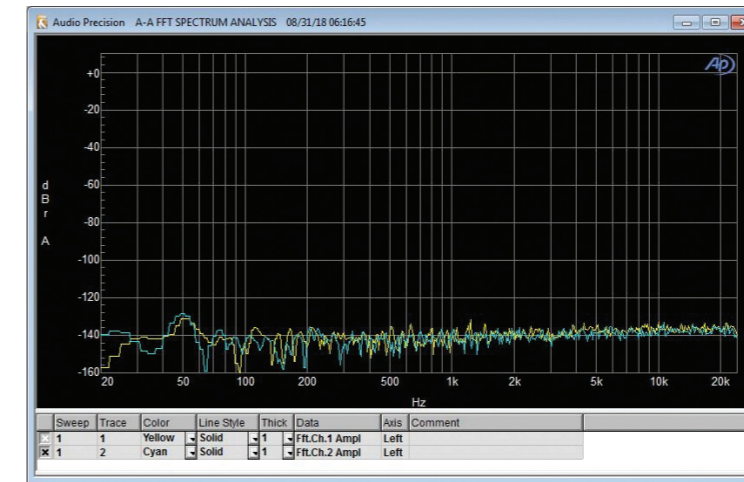
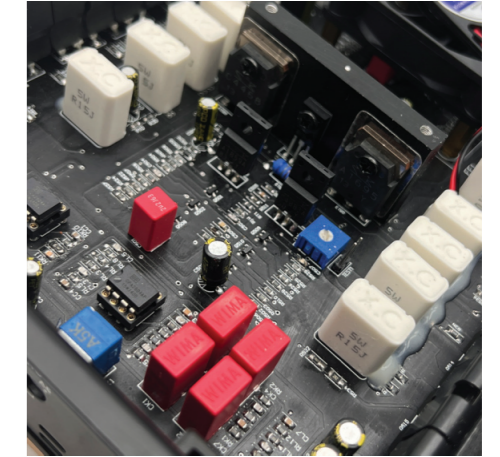

Class, Power, Heat

When buying or selling a car audio amplifier you need to consider more than just the power output. The basic design platform of the amplifier (Amplifier Class) will influence how the amp will work in any given situation, for any given user. All amplifiers make small signals bigger and in doing so create heat. Class A produces the most heat and Class D produces the least. If the amplifiers are not properly cooled, they will get too hot and problems will arise. Either the amp will be damaged, or protection circuits will engage to shut the amp off until it has cooled down enough to safely work again. Conversely, better cooling will allow an amp to make more power, longer, without damage or thermal shut down.

Class A/B amplifiers are used when audio fidelity is the primary goal and efficiency is of secondary concern. Class A/B amps have superior sound quality but with lower efficiency, they generate more heat and need more cooling.

Sound Quality and Dynamic Range: Our amps are designed solely for the best possible sound quality, so we do not current limit the amps. This gives Zapco amps more Dynamic Range than other amplifiers. Dynamic range, the ability to go from very quiet to extremely loud without distortion, is a major reason Zapco amps sound better than others. So, with Z-AP amplifiers, consumers have more dynamics plus the sound quality of class A/B amplifiers. If the Zapco Class A/B are used at the maximum dynamic range without distortion, they don't need so much cooling and never will shut down. But if they are driven into its distortion the amplifier will more easily reach maximum temperature and will shut down.

Critical: Volume does not make a system sound loud. Distortion sounds loud. With clean sound it is easy to drive an amp to full power and not know it because it still sounds clean. But when the power requested of the amplifier takes it into distortion the amplifier will overheat and shut down... and possibly be damaged. Zapco offers both Class A/B and Class D amps. Class A/B for the user who puts sound quality and dynamics first, and Class D for the user who wants big power in a small box.

Installation and Cooling: All the amplifiers need cooling, whether they are class A/B or class D. For cooling, the heatsink of the amplifier needs to exchange heat with air around it. So, the amplifier cannot be covered or put in a space where there is not enough air or ventilation. As noted above, in many cases a good installation needs to use external fans to make the ventilation more efficient. Some amplifiers have fans inside, but the problem is not solved if the fans cannot have an exchange of air with the environment.

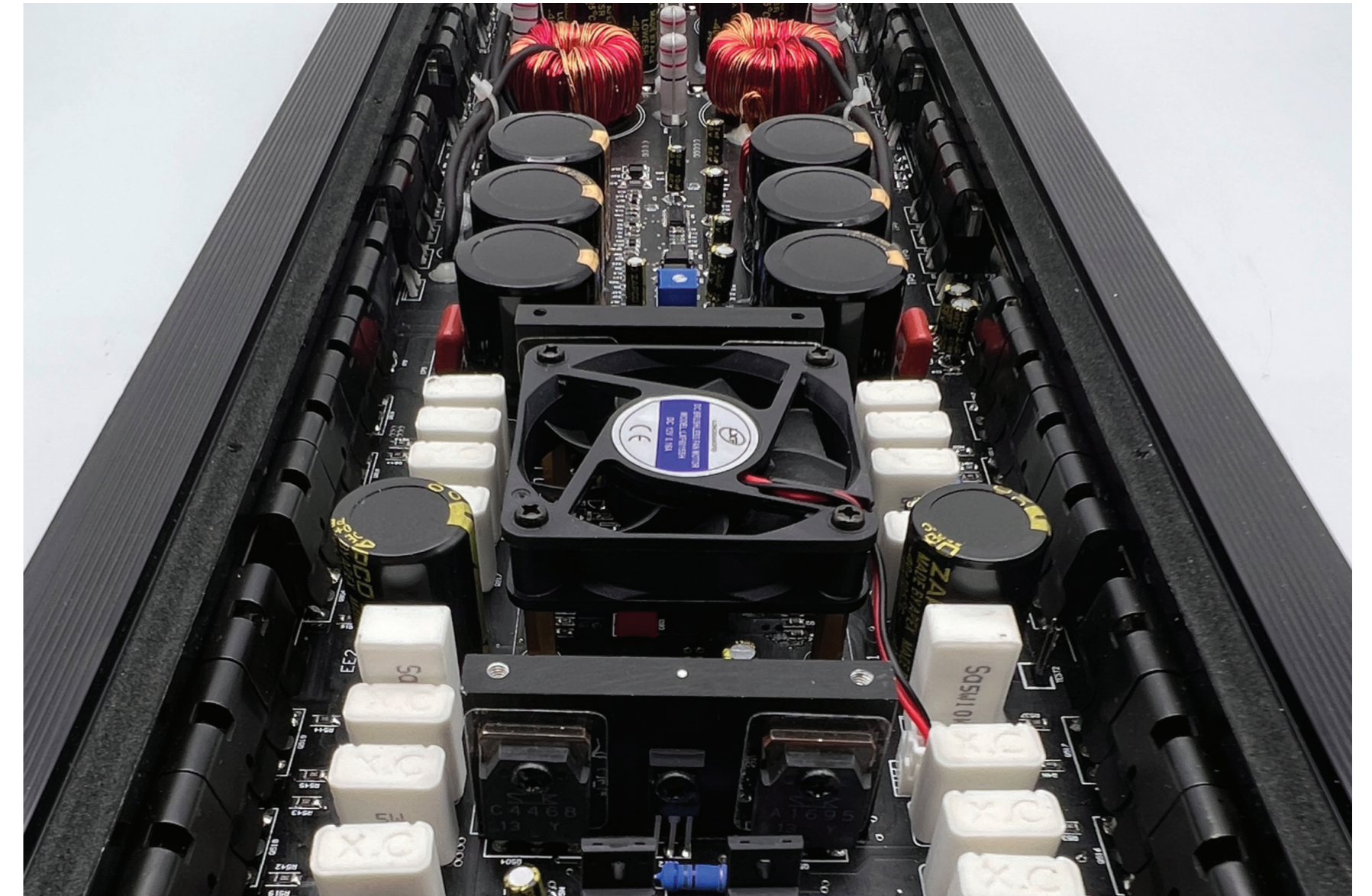
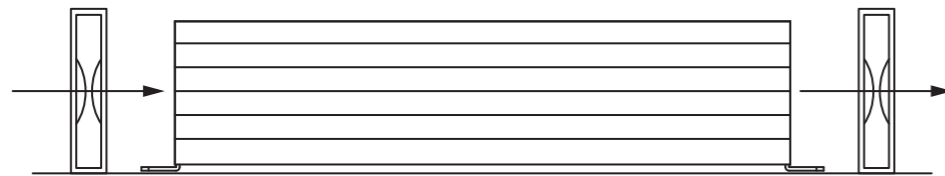

All Wire is not created equal

Do not use CCA wire with Zapco amplifiers

It is easy to think of wire as just wire but the fact is there are major differences between the types of wires being offered today. The price of copper has gone up quite a bit lately, but you will notice that you can still buy heavy primary wire at very reasonable prices. How can this be? Simple... That lower price wire is not all copper, it is CCA wire. CCA stands for Copper Clad, Aluminum. That means it is aluminum wire with a thin coating of copper around the outside of the wire.

Does it look like copper wire? Absolutely. But does it conduct electrical current like copper? Absolutely Not.

Two things can and likely will happen:

- Because CCA wire can not conduct DC electrical current like copper wire can, your amp will not get the current it needs to produce its rated power. That means you get less power and more distortion. It also taxes the amplifier that is trying to make its power, shortening the life of the amp
- CCA wire corrodes quickly and causes terminals that used to be tight to become loose. This causes arcing when electrons to fly around all the open space lookin for more copper. This causes heat that damages connections and can even eventually melt the terminal blocks on your amplifier

In short: While CCA wire is excellent for high frequency AC current (like tweeter voice coils), it is absolutely bad for high current 12V DC like power and ground for a car audio amplifier. We have seen CCA wire become a major cause of amplifier failures as buyers are offered CCA as a low cost alternative to pure copper wire.

So always look at the description of the contents of wire that you purchase. When someone offers to save you some money with CCA wire just say "No, thank you".

Protect your investment with real copper wire.

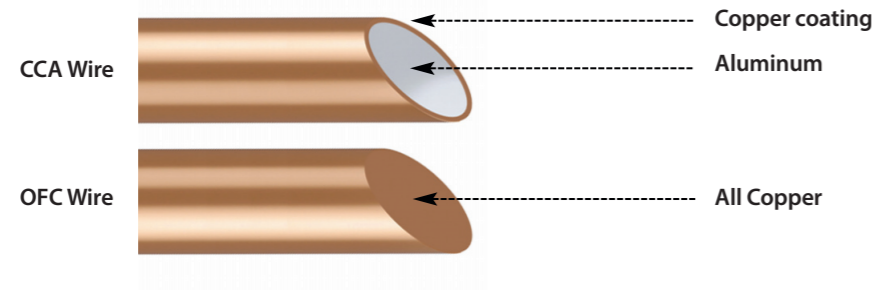

Wire Size

The second most common cause of under performing amplifiers is insufficient power current or a poor power connection. The most common cause of under performing amplifiers is insufficient ground current or a bad ground connection. 12-volt current: Battery power works only if it travels in a complete circuit from the battery positive terminal to the battery negative terminal. Main power input, of course, is attached to the battery positive terminal. Ground current is returned to the battery through the chassis to the point where the battery is grounded. The current available for your amplifier to use to produce power will be restricted by the smallest gauge of wire in the circuit and by the weakest physical connection in the circuit.

It's often surprising how many people will obsess about signal wire but routinely provide the amplifier with only a fraction of the current it needs to do its job.

The most common wire gauge used in car audio is 10-gauge, and the most common location for amplifiers is in the trunk.

Wire Sizing Chart	Length							
	4 ft	7 ft	10 ft	13 ft	16 ft	19 ft	22 ft	28 ft
0-20 amps	14	12	12	10	10	8	8	8
20-35 amps	12	10	8	8	6	6	6	4
35-50 amps	10	8	8	6	6	4	4	4
50-60 amps	8	8	6	4	4	4	4	2
65-85 amps	6	6	4	4	2	2	2	0
85 -105amps	6	6	4	2	2	2	2	0
105-125 amps	4	4	4	2	2	0	0	0
125-150 amps	2	2	2	2	0	0	0	0

Let's look at a fairly small system. If you use a 50 watt/ch amp (25 amps) for the highs and a 100 watt/ch amp (40 amps) for the woofers, you need at least a 4-gauge and maybe a 2-Guage wire to provide 65 amps at the trunk. Use the Wire Sizing Chart. Add up the fuse values on the amplifier(s) then choose the proper size wire based on the distance from the car battery to the amplifier location. Always use the same gauge wire for the main ground as you do for the main power. Always make your ground as short as possible and secure it to a clean solid surface, preferably the vehicle frame.

1-Ch. Amplifier Controls

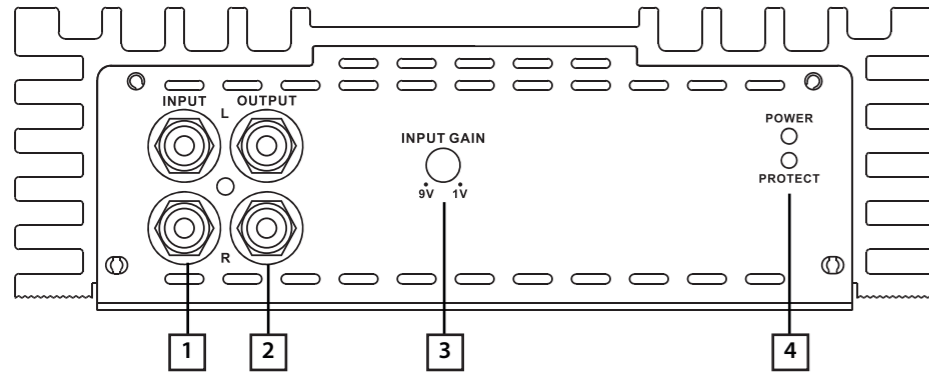

- 1• RCA Inputs
- 2• Pass-through RCA outputs so you can "daisy-chain" multiple amps while only running one front-to-back RCA
- 3• Variable gain control
- 4• The power on (green) LED and the protect (red) LED

2-Ch. Amplifier Controls

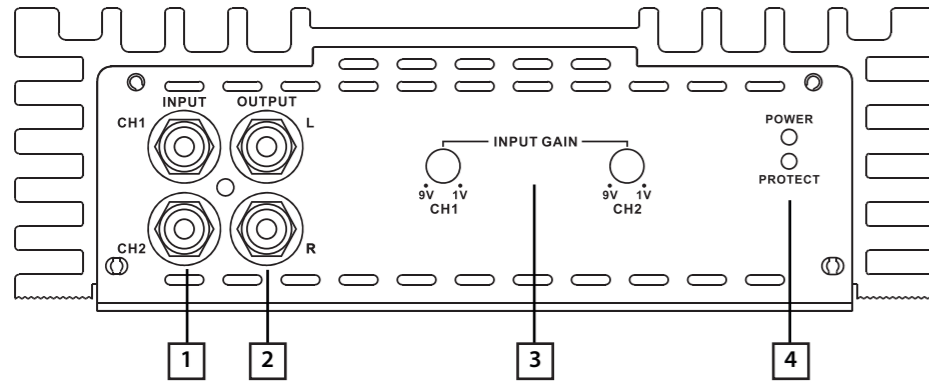

- 1• RCA Inputs
- 2• Pass-through RCA outputs so you can "daisy-chain" multiple amps while only running one front-to-back RCA
- 3• Variable gain control
- 4• The power on (green) LED and the protect (red) LED

4-Ch. Amplifier Controls

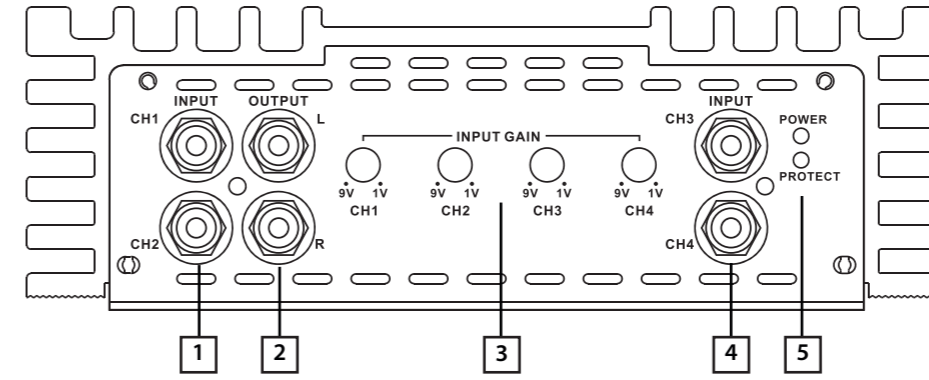

- 1• Ch. 1 and Ch. 2 RCA input connectors using Zapco's proprietary gold plated connectors
- 2• Pass-through RCA outputs so you can "daisy-chain" multiple amps while only running one front-to-back RCA
- 3• Variable gain control
- 4• Ch. 3 and Ch. 4 RCA input connectors using Zapco's proprietary gold plated connectors
- 5• The power on (green) LED and the protect (red) LED

6-Ch. Amplifier Controls

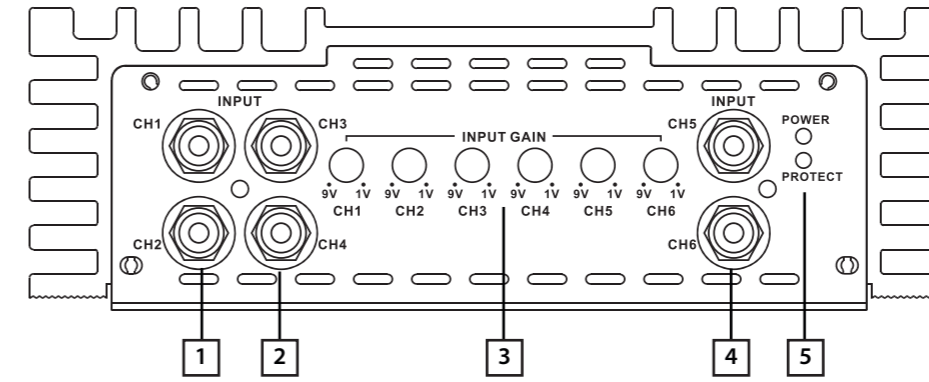

- 1• Ch. 1 and Ch. 2 RCA input connectors using Zapco's proprietary gold plated connectors
- 2• Ch. 3 and Ch. 4 RCA input connectors using Zapco's proprietary gold plated connectors
- 3• Variable gain control
- 4• Ch. 5 and Ch. 6 RCA input connectors using Zapco's proprietary gold plated connectors
- 5• The power on (green) LED and the protect (red) LED

2-Ch. Amplifier - Stereo Mode

A simple 2 channels hookup for a right and left stereo pair.

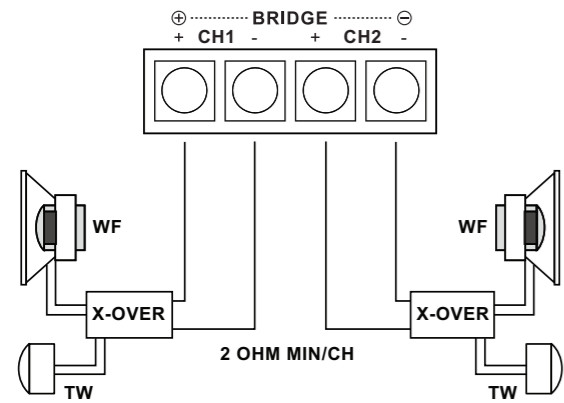

2-Ch. Amplifier - Single Channel Mode

This method is used most often to drive a mono woofer but can also be used to run separate amplifiers for the right and left channel. The bridged speaker must be of 4Ω minimum impedance.

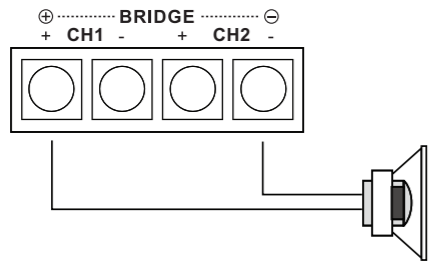

2-Ch. Amplifier - 3Ch Mode

It is possible to run the 2-Ch. amps in "3-Channel" mode by running a pair of speakers for the mids and highs on left and right channels, and at the same time run a woofer bridged between the L+ and R- terminals as shown. However, since each channel will see 1/2 the impedance of the woofer you must use a woofer of no less than 4Ω. The amplifier sees impedance by frequency, so you can have two 2Ω loads but you must use a passive crossover on each speaker in the 3-Ch. mode. With the crossovers in the line, the amplifier will always see a minimum load of 2Ω on each channel at all frequencies. Main speakers can be 2Ω~4Ω. Woofer can be 4Ω~8Ω but cannot be less than 4Ω. A 3-Way hookup requires a coil on the woofer and capacitors on the highs to act as a crossover and maintain correct impedance. Consult the speaker manufacturer for correct cap and coil values.

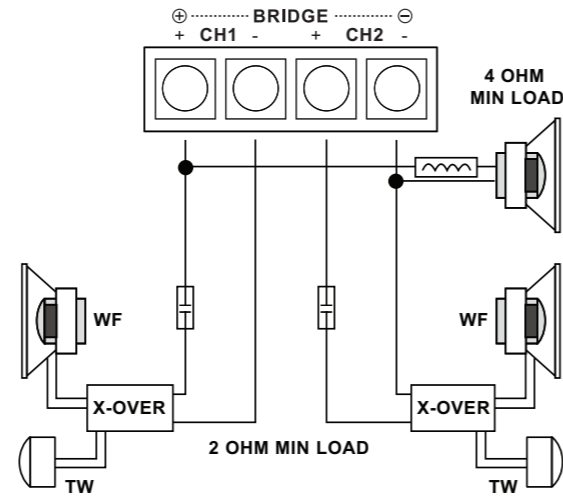

4-Ch. Amplifier - Stereo Mode

A simple 4 channels hookup for a right and left stereo pair. This is the standard hookup for full range front and rear speakers.

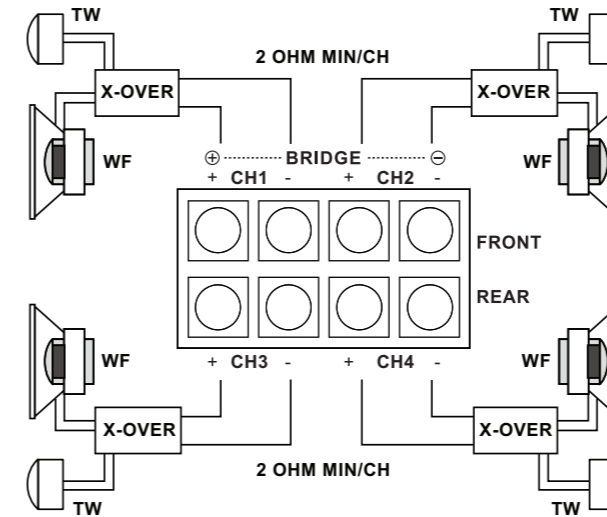

4-Ch. Amplifier - High Power 2-Ch. Mode

Want more power? Instead of 4 channels of 150 watts, you can have two channels of 500W each by bridging both front and rear amp sections to one speaker each.

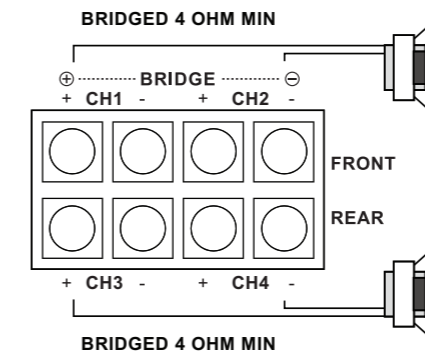

4-Ch. Amplifier - 5-Ch. Mode

A 3-way system with front stage, rear stage and subwoofer in mixed mono configuration. The 5-speakers system requires a passive crossover between the front highs and the mono woofer, with capacitors on the front highs positives and a coil on the woofer positive. All amplifiers channels are full range.

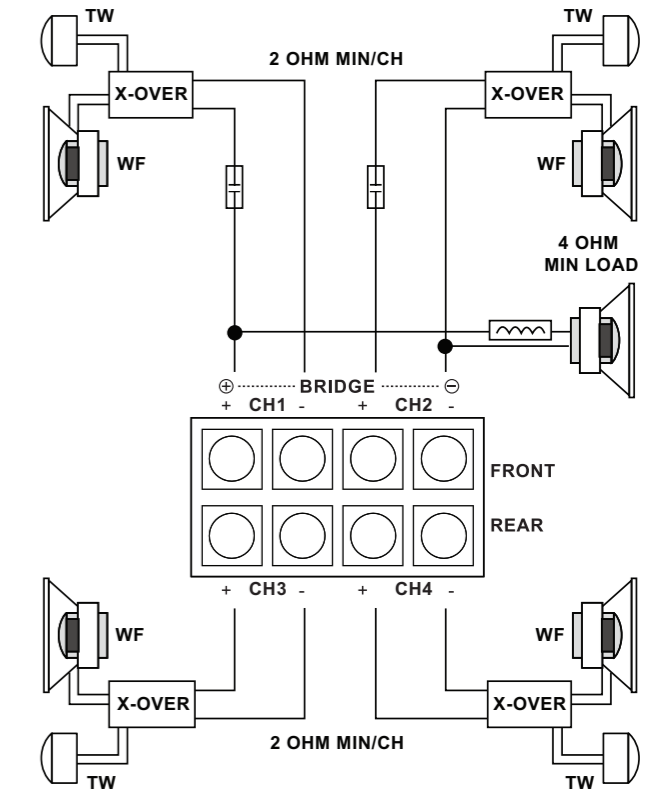

6-Ch. Amplifier - 5-Ch. Mode

The most popular system for a six channel amplifier is right/left front, right/left rear, and a mono sub. Note the hookup especially of the sub as Ch5+ and Ch6-. This gives the sub the combined power of the 2 channels. Note that since the sub is a bridged hookup the sub must be 4Ω minimum.

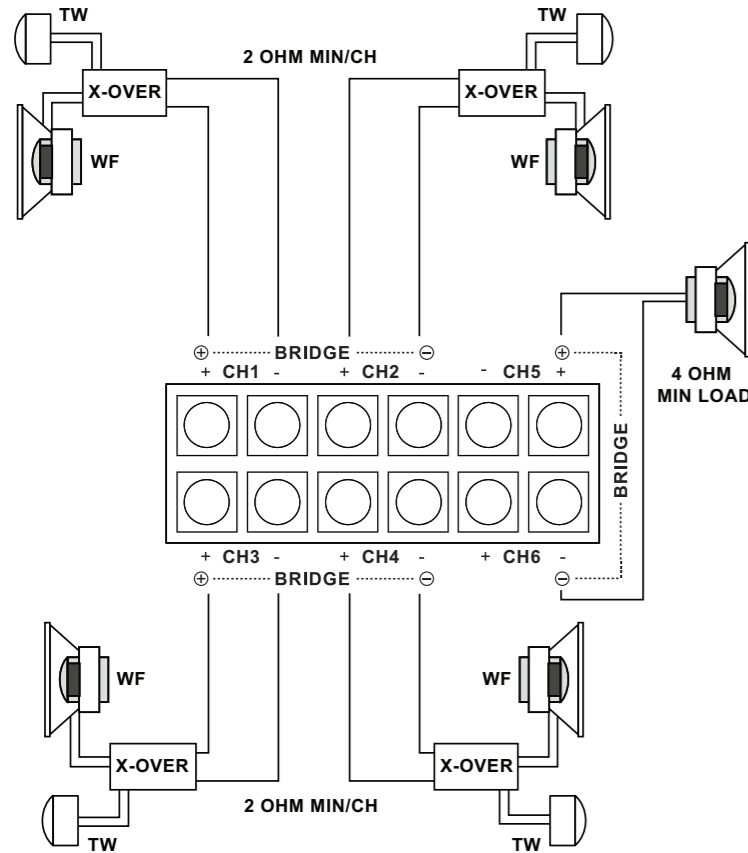

1-Ch. Amplifier

A simple 1 channel hookup for a single speaker or two speakers. The speakers must be 2Ω minimum.

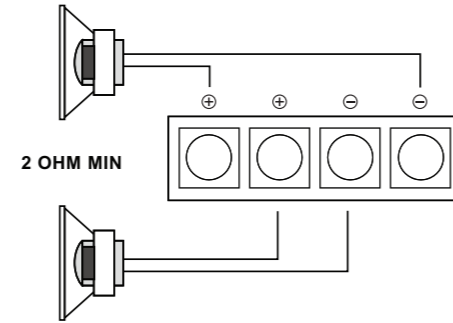

Technical Specifications

Model	Type	Power (W) Channel/RMS	THD	S/N	Frequency Response	Net/Overall Dim. (mm, WxHxL)
Z-150.2 AP	2-Ch, Class AB	2 x 150 (4Ω) / 2 x 275 (2Ω) / 2 x 500 (1Ω)* 550 (Br, 4Ω) / 1000 (Br, 2Ω)*	< 0.1%	>110dB	10Hz ~ 30KHz	190 x 62 x 300 / 190 x 62 x 328
Z-300.2 AP	2-Ch, Class AB	2 x 300 (4Ω) / 2 x 500 (2Ω) / 2 x 800 (1Ω)* 1000 (Br, 4Ω) / 1600 (Br, 2Ω)*	< 0.1%	>110dB	10Hz ~ 30KHz	190 x 62 x 450 / 190 x 62 x 478
Z-600.2 AP	2-Ch, Class AB	2 x 600 (4Ω) / 2 x 1000 (2Ω) / 2 x 1600 (1Ω)* 2000 (Br, 4Ω) / 3200 (Br, 2Ω)*	< 0.1%	>110dB	10Hz ~ 30KHz	190 x 62 x 600 / 190 x 62 x 628
Z-150.4 AP	4-Ch, Class AB	4 x 150 (4Ω) / 4 x 275 (2Ω) / 4 x 400 (1Ω)* 2 x 550 (Br, 4Ω) / 2 x 800 (Br, 2Ω)*	< 0.1%	>110dB	10Hz ~ 30KHz	190 x 62 x 440 / 190 x 62 x 468
Z-150.6 AP	6-Ch, Class AB	6 x 150 (4Ω) / 6 x 275 (2Ω) / 6 x 500 (1Ω)* 3 x 500 (Br, 4Ω) / 3 x 1000 (Br, 2Ω)*	< 0.1%	>110dB	10Hz ~ 30KHz	190 x 62 x 600 / 190 x 62 x 628
Z-1100.1 AP	Mono, Class AB	650 (4Ω) / 1100 (2Ω) / 1600 (1Ω)*	< 0.1%	>110dB	10Hz ~ 30KHz	190 x 62 x 480 / 190 x 62 x 588
Z-2000.1 AP	Mono, Class AB	1200 (4Ω) / 2000 (2Ω) / 2400 (1Ω)*	< 0.1%	>110dB	10Hz ~ 30KHz	190 x 62 x 600 / 190 x 62 x 628

***Important Note:** AP amplifiers are stable on 1Ω and 2Ω Bridged only when used with music signal. The limits of the amplifiers to deliver power over time are not dependent on the load impedance, but rather on their ability to dissipate the heat produced. If this is not possible, the amplifier will go into protection mode. Furthermore, several protection cycles, repeated in a short time interval, can irreparably damage the amplifier.

ARPA of AMERICA, 290 Beeline Dr, Bensenville, IL 60106 - USA

ARPA of EUROPE, Via Isonzo snc, Centro L'Orologio - 04100 Latina - ITALY

ARPA of CHINA, 东莞市艾柏贸易有限公司 Room201,Unit 7, Dahongshan Industrial zone, No.143 Guanlong Road, Guancheng Street, Dongguan City, Guangdong Province, CHINA, 523008

地址: 广东省东莞市莞城街道莞龙路143号大宏山工业区7单元201室

APEX GROUP - APEX Business Development (ABD) CO LTD, Bright Way Tower, office 04 7/FI, 33 Mong Kok Road Kowloon City, Hong Kong 999077



[fb.com/zapcocaraudio](https://www.facebook.com/zapcocaraudio)

[instagram.com/zapco_official](https://www.instagram.com/zapco_official)

ZAPCO is a brand of APEX Group © All rights reserved. Manual v.23.09.07

Modesto, California USA
Since 1974

zapco.com